

Self Contained Wireless Alarm System v1.0



DSC®

WARNING: This manual contains information on limitations regarding product use and function and information on the limitations as to liability of the manufacturer. The entire manual should be carefully read.



SAFETY INSTRUCTIONS for SERVICE PERSONNEL

WARNING: When using equipment connected to the TELEPHONE NETWORK, there are basic safety instructions that should always be followed. Refer to the SAFETY INSTRUCTIONS provided with this product; save them for (future) reference. Instruct the end-user regarding the safety precautions that shall be observed when operating this equipment.

Before Installing The Equipment

Do NOT use a sharp or metal object to open the packaging!

Ensure your package includes the following items:

- User's Guide (Manual) including the SAFETY INSTRUCTIONS.
READ and SAVE These Instructions!
Follow All WARNINGS AND INSTRUCTIONS specified within these Instruction and/or on the equipment.
- Equipment SCW904x
- Power Supply, Direct Plug-In
- Mounting Hardware.

Selecting A Suitable Location For The Alarm Controller

Use the following list as a guide to find a suitable place for this equipment:

- Locate it near a telephone socket and a power outlet.
- Select a place that is free from vibration and shocks.
- Place the Alarm Controller on a flat, stable surface and follow the Installation suggestions.

Do NOT locate this product where persons will walk on the secondary circuit cable(s).

Do NOT use extension cords to PLUG-IN the Power Supply of this equipment.

AVOID setting up the equipment near heaters, air conditioners, ventilators, and/or refrigerators

Do NOT connect the Alarm Controller to electrical outlets on the same circuit as large appliances.

Do NOT select a place that exposes your alarm controller to direct sunlight, excessive heat, moisture, vapors, chemicals or dust.

Do NOT install this Equipment near water. (e.g., Bath Tub, Wash Bowl, Kitchen/Laundry sink, In a wet basement, or near swimming pool, etc.).

Do NOT install this equipment and its accessories in areas where there is a risk of explosion.

Do NOT connect this Alarm Controller to electrical outlets controlled by wall switches or automatic timers; avoid interference sources.

SAFETY Precautions required during Installation:

- **NEVER** install this EQUIPMENT and/or TELEPHONE WIRING during A Lightning Storm!
- **NEVER** touch uninsulated Telephone wires or Terminals unless the telephone line has been disconnected at the network interface.
- Ensure that Cables are positioned so that accidents can not occur. Connected Cables must NOT be subject to excessive mechanical strain
- Use Only the Power Supply supplied with this equipment. Use of unauthorized power supplies may cause damage.
- The AC Socket/Outlet powering the equipment shall be located near the equipment and shall be easily accessible.

WARNING:

THIS EQUIPMENT HAS NO MAINS ON/OFF SWITCH. THE PLUG OF THE DIRECT PLUG-IN POWER SUPPLY IS INTENDED TO SERVE AS THE DISCONNECTING DEVICE IF THE EQUIPMENT MUST BE QUICKLY DISCONNECTED. IT IS IMPERATIVE THAT ACCESS TO THE MAINS PLUG AND ASSOCIATED MAINS SOCKET/OUTLET, IS NEVER OBSTRUCTED.

Table of Contents

Section	Description	Page
1	Installation & Wiring	1
1.1	Installation	2
1.2	Wiring.....	3
	1. Zone Wiring.....	3
	2. PGM/AUX Power Wiring.....	3
	3. Telephone Line Wiring.....	3
	4. Battery.....	3
	5. AC Wiring	3
2	Wireless Device Enrollment	5
3	Template Programming	7
4	DLS Programming	10
4.1	Local programming with PC-Link	10
4.2	Remote Programming (via telephone line).....	10
5	Operation	11
5.1	Away Arming	11
5.2	Stay Arming.....	11
5.3	Disarming	11
5.4	[*] Commands.....	11
5.5	Function keys	13
6	Advanced Programming	14
6.1	How to Program	14
6.2	Programming Toggle Options.....	14
6.3	Programming Decimal & Hexadecimal Data.....	14
6.4	How to Exit Installer Programming	14
6.5	Viewing Programming	14
7	Programming Worksheets	15
7.1	Index Programming Worksheets	15
7.2	Programming Worksheets.....	16
8	Programming Descriptions	33
9	Testing & Troubleshooting	48
App A	Reporting Code Formats (Contact ID, SIA)	50
App B	Communicator Format Options	52
App C	Regulatory Approvals Information	54
App D	SIA False Alarm Reduction Quick Reference Chart	56
App E	2-Way Audio Verification	57

Section 1: Installation & Wiring

This Installation Guide provides the basic installation, wiring and programming information for the PowerSeries Self Contained Wireless (SCW) Security System.

This publication covers the following versions of the SCW Security System:

SCW9045-433 v1.0
SCW9047-433 v1.0

SCW9045-868 v1.0
SCW9047-868 v1.0

These models are not UL/ULC Listed (intended for European market only)

TECHNICAL SUMMARY

Specifications

Temp Range.....	0°C-49°C (32°F-120°F)
Humidity (Max).....	93%RH Non Condensing.
Power Supply	16.5VAC/20VA @50/60Hz.
Current Draw from Transformer.....	400mA AC (Max.)
Aux+ Output	12.0-12.5VDC/100mA

Features

Wireless Zones	32
*On-board I/O.....	2
Partitions	1
Wireless Keys.....	16
User Codes	16 + 1 Master Code
Event Buffer	128 Events
LCD Display	2 Rows x 16 Char
Plug-in Transformer.....	Secondary 16.5 VAC/20-40VA
Battery Backup.....	7.2VDC@1500 mAH (24Hr Backup)

* I/O Terminals can be configured as Zone Inputs or PGM Outputs
When configured as PGMs, outputs are 50mA

Compatible Wireless Devices

SCW9045-433 v1.0	all DSC 433 or 433EU Devices
SCW9047-433 v1.0	all DSC 433 or 433EU Devices
SCW9045-868 v1.0	all DSC 868 Devices
SCW9047-868 v1.0	all DSC 868 Devices

UL Listed Wireless Devices

WS4904(P).....	PIR Motion Detector
WS4916	Smoke Detector
WS4945	Door Contact
WS4965	Door Contact
WLS912L-433	Glass Break Detector
WLS914-433	PIR Motion Detector
WS4938	Panic Pendant
WS4939	Wireless Key

Classified in Accordance with ANSI/SIA CP-01-2000 (SIA-FAR)

IMPORTANT NOTE!

This equipment, SCW Alarm System shall be installed and used within an environment that provides the pollution degree max 2 and over-voltages category II NON-HAZARDOUS LOCATIONS, indoor only. The equipment is DIRECT PLUG-IN connected and is designed to be installed, serviced and/or repaired by **service persons** only; [service person is defined as a person having the appropriate technical training and experience necessary to be aware of hazards to which that person may be exposed in performing a task and of measures to minimize the risks to that person or other persons]. There are no parts replaceable by the end-user within this equipment.

The power supply must be **direct plug-in, fail safe, with double or reinforced insulation between primary and secondary circuits**. In EU countries it must meet the applicable requirements of the Low Voltage Directive and protected as per the EN60950-1:2001 Standard Requirements. In all other countries, it must be of an approved type acceptable to the local authorities; it is the **installer's responsibility** to ensure that the socket-outlet that the transformer is plugged-in, is near the equipment and is easily accessible.

The wiring (cables) used for installation of the **SCW Alarm System and accessories**, shall be insulated with PVC, TFE, PTFE, FEP, Neoprene or Polyamide.

- The equipment enclosure must be secured to the building structure before operation.
- Internal wiring must be routed in a manner that prevents:
 - Excessive strain on wire and on terminal connections;
 - Loosening of terminal; connections;
 - Damage of conductor insulation
- Disposal of the used battery packs shall be made according to the waste recovery and recycling regulations applicable to the intended market.
- Before servicing, DISCONNECT the power and telephone connection.
- Do NOT route any wiring over circuit boards.

1.1 Installation:

- 1 If required, separate the front and back covers by removing the cover screw then inserting a small slotted screw driver between the front and back covers and gently twist the screwdriver to separate.
- 2 Route Telephone line wiring, I/O Wiring, and AC power through a single or double ganged junction box and through cutout in the back cover see Fig. 2 Mounting & Wiring details. If Programming with DLS, See "4.1 Local Programming with PC-Link" on page 10. If using Template programming or Advanced Keypad programming continue to the next step.
3. Secure the back cover to the junction box with the screws provided (2 screws for single ganged box or 4 screws for a double ganged box). For drywall (surface mount) secure to wall using 4 #6 3/4" wood screws and drywall plugs. See figure 2, Mounting & Wiring Details for hole locations.

i *If mounting unit on a double ganged box with the wall tamper feature, secure the back plate to the right side of the ganged box using the center mounting holes. This will provide the tamper switch with unobstructed access to the wall surface*

4. Connect wiring to the terminals indicated. See Section 1.2 Wiring for details.

i *Do NOT apply power until wiring is completed.*

5. Connect battery cable connector to the PC Board.

i *Ensure connector key is oriented correctly.*

6. Position the cover onto the back plate. Ensure tamper switch is positioned for effective operation.
7. Insert cover in the lower slot at a 35° to 55° angle then snap cover in place. An audible click will be heard.
8. Apply power to System.
9. Enroll devices. Enter [*][8][Installer Code][898]. See Section 2, Wireless Device Enrollment.
10. If performing Template programming, enter [*][8][Installer Code][899]. See Section 3, Template Programming
11. Enter Advanced Programming if required. See Section 5, Advanced Programming.
12. Test System by violating zones and verifying successful transmission to the central station.

i *See DLS Programming on page 10 for reprogramming an existing Installation.*

i *AC Power must be present for the Alarm system to answer Incoming calls from DLS*

i *After the initial installation 24 Hrs. is required to fully charge the standby battery.*

Figure 1, Opening Cover

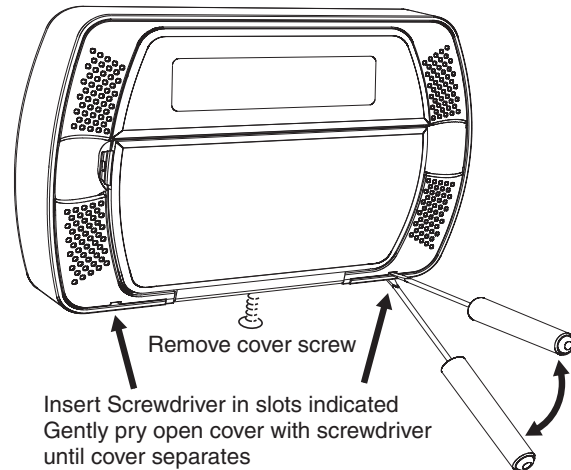
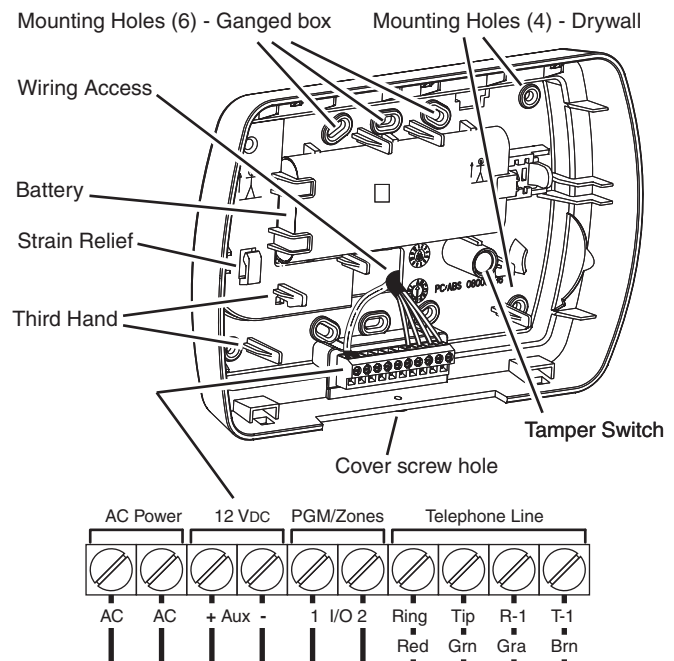

Figure 2, Mounting & Wiring Details



1.2 Wiring

1. Zone Wiring

Zones can be wired for Normally Open, Normally Closed Contacts with Single-end-of-line (SEOL) resistors or Double End-of-Line (DEOL) resistors. Observe the following guidelines

- For **UL/ULC** listed installations use SEOL or DEOL only.
- Minimum 22 AWG wire, maximum 18 AWG
- Do **NOT** use shielded wire
- Wire run resistance shall not exceed 100Ω. Refer to the chart below.

Burglary Zone Wiring Chart	
Wire Gauge	Max wire Length to End-of-line Resistor (feet/meters)
22	3000 / 914
20	4900 / 1493
19	6200 / 1889
18	7800 / 2377
Figures are based on maximum wiring resistance of 100Ω	

- Section [009] Selects Hardwired Zone Definition
- Sections [133], [134] Opt [14] selects Normally Closed
- Sections [133], [134] Opt [15] selects SEOL resistors
- Sections [133], [134] Opt [16] selects DEOL resistors.

Zone Status - Loop Resistance/Loop Status

- Fault** - 0Ω (shorted wire/loop)
- Secure** - 5600Ω (contact closed)
- Tamper** - infinite (broken wire, open)
- Violated** - 11,200Ω (contact open)

Normally Closed Loops - Do NOT use for UL Installations

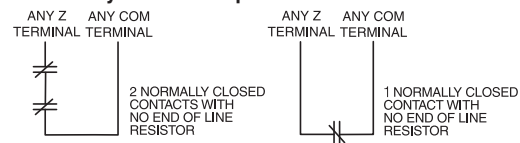

Single End-of-Line Resistor Wiring

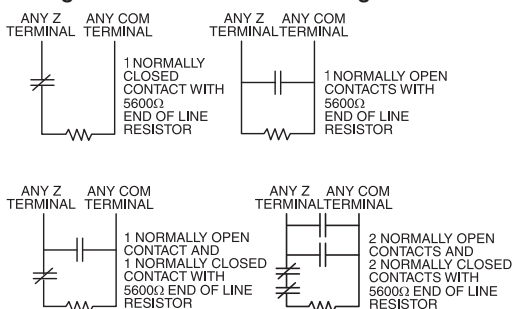

Double End-of-Line Resistor Wiring

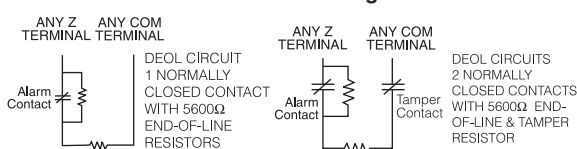

2. PGM/Aux Power Wiring

PGMs switch to ground when activated by control panel. Connect the plus side of the device to be activated to the AUX+ Terminal. Connect the minus terminal to the PGM. Each PGM can provide 50mA output.

NOTE: The control panel can provide a maximum of 100mA of AUX current for PGMs, relays, LED's etc. Min/Max operating voltages for PGMs, relays and modules is 10.2VDC - 13.75VDC

NOTE: Battery Voltage (6.0-8.4VDC) is boosted internally to supply 12VDC on the AUX+ output by setting Sect[014] Opt[4] to ON. This option must be enabled for PGMs used in UL/ULC Residential Burg installations. This output can NOT be used for UL/ULC Fire installations.

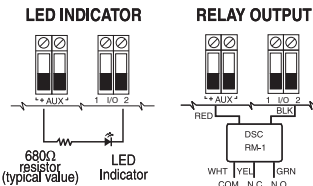

LED output with current limiting resistor and optional Relay driver output

IMPORTANT: Minimum 6.4mm (1/4") separation must be maintained between RM-1 circuits and all other wiring

3. Telephone Line Wiring

Wire the telephone connection terminals (TIP, Ring, T-1, R-1) to an RJ-31X Connector as indicated. Use 24 AWG wire minimum for wiring.

For connection of multiple devices to the telephone line, wire in the sequence indicated.

Communication format is programmed in section [350].

Telephone Call Directions are programmed in section [351]-[376].

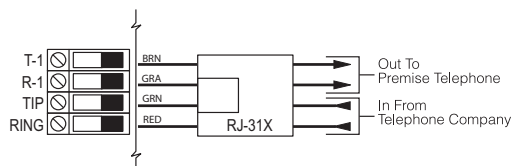

Note: For UL Listed Installations, the Installer must verify the communication format with the supervising station at the time of the installation.

4. Battery

A 1500 mAh Ni-Mh battery pack is included to meet standby power requirements

NOTE: UL/ULC Residential Burglary installations require 4 Hr. power standby time plus 4 minutes alarm annunciation.

NOTE: UL/ULC Residential Fire installations require 24 Hr. power standby plus 5 minutes alarm annunciation

NOTE: Battery life is 4-5 years under typical operating conditions. Battery capacity deteriorates with age and number of charge/discharge cycles. Replace battery every 4-5 years.

5. AC Wiring

AC Transformer Requirements:

Primary: 120VAC, 50/60Hz., 0.33A

240VAC, 50/60Hz., 0.165A

Secondary: 16.5VAC/20VA

The following Transformers shall be used:

UL Listed Installations - PTD1620U, PTD1640U (60Hz.)

ULC Listed installations - PTD1620, PTD1640 (60Hz.)

EU Installations - PTD1620T-EU (50 Hz.)

**NOTE: Do not connect transformer to a receptacle controlled by a switch.
For UL/ULC Installations use a Class 2, power limited, plug-in transformer**

Section 2: Wireless Device Enrollment

Before a wireless device can be recognized by the security system, it must be enrolled. Devices that are not enrolled will be ignored by the system. See “Section [904]: Wireless Module Placement Test” on page 44.

- i** *Device Enrollment must be performed close to the alarm system.
Maximum signal strength is required to ensure that the correct device is being enrolled.*

1. Enter Wireless Enrollment Mode

Enter [*][8] [Installer Code] [898] on the system keypad.

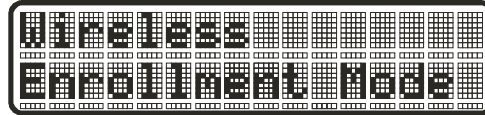

2. Activate Wireless Device

- For FOBs & Panic Pendants - **Press any button**
- For PIRs, Smoke and Glass Break Detectors - **Activate Tamper**
- For Contact Switches - **Close Contacts**

3. Verify Device Electronic Serial Number (ESN)

When a device is activated the Alarm system will display the corresponding 6-digit ESN on the keypad. Verify that the ESN displayed corresponds to the ESN on the device.

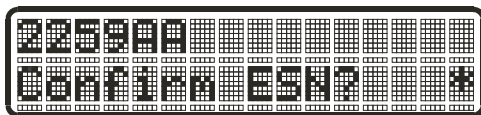

Note: The first digit of the ESN indicates the following:

2	denotes contact
3	denotes PIR/Glass Break Detector
4	denotes Smoke Detector
5	denotes Pendant
6&9	denotes FOB

4. Press [*] to confirm correct ESN, or press [#] to delete device if incorrect.

If the ESN displayed on keypad does NOT correspond to the ESN on the device being enrolled.

- Deactivate the wireless device
- Press the # key to repeat the enrollment process.
- Perform these steps until the correct ESN is displayed

- i** *If the device fails to enroll (i.e., incorrect ESN) attempt manual programming and testing of the device before determining that the device is faulty. Maximum signal strength is required to ensure that the correct device is being enrolled.*

5. Enter Zone Number

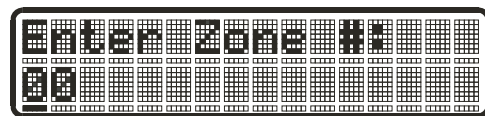

After confirming that the device ESN is correct, the installer will be prompted to enter a zone number.

- i** *If the installer selects a zone that is currently in use, the installer will be prompted to overwrite the current zone or select a new zone. If all zones are in use the installer will be prompted to overwrite the selected zone.*

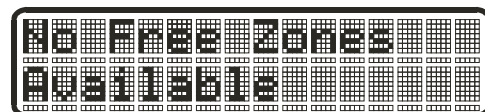

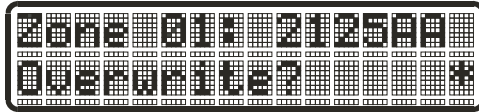

i If the installer attempts to enroll a device already on the system, the keypad will briefly indicate that it is a duplicate ESN.

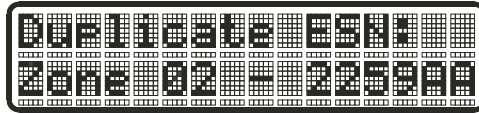

Place wireless detectors in the desired locations and perform the wireless placement test.
Reposition devices if necessary to achieve the required signal strength.

Zone Dependant Devices (Detectors)

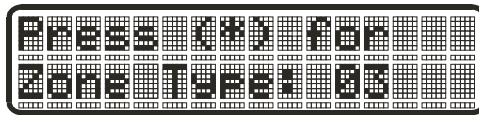

After the zone has been selected the keypad will display zone type 03. The Installer may enter an alternate zone type if required. When the zone type has been selected the device will be enrolled.

For FOBs, the device is enrolled when the slot is selected. Zone type is not requested.

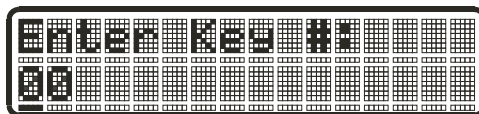

Section 3: Template Programming

Template programming allows the Installer to quickly program the minimum functions required for basic operation. The installer is prompted to enter a 4-digit code that selects predefined zone definitions, reporting code formats, Troubles & Restorals, and DLS setup (see Digit 1 - 4 tables below). The Installer is then prompted to enter the Central Station Telephone Number & Account Code, DLS Access Code, Entry & Exit Delays and Installer Code (see entry 5-9 below).

Selecting [*][8] [Installer Code] [899] displays the default settings for the first 4 options below.



Once this section has been entered, the Installer cannot exit until all sections are completed.

Enter new data and/or Press # key to accept the displayed data and proceed to the next section.

Changing a single digit, then pressing the # key will advance to the next section but will not save the changed data. Enter all 4 digits or scroll to the end of template programming and exit to save data.

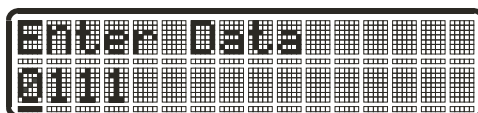

- Digit 1 selects 1 of the following 6 options for Zone definitions for the first 8 zones. A '0' in the digit 1 location indicates that the default settings for the first 8 zones are in place unless overridden. See Section [001]-[002] on page 16 for defaults.

Option	Zn1	Zn2	Zn3	Zn4	Zn5	Zn6	Zn7	Zn8
1	1	3	3	3	4	4	4	4
2	1	3	3	5	5	5	5	88
3	1	3	3	5	5	5	5	87
4	1	1	3	3	3	3	3	3
5	1	3	3	6	5	5	5	5
6	1	3	3	6	5	5	5	88
Refer to Section 8 for zone definition details								

Zone Definitions (Options 1- 6)
1 Delay 1
2 Delay 2
3 Instant
4 Interior
5 Interior Stay/Away
6 Delayed Stay/Away
87 Delayed 24Hr. Fire (Wireless)
88 Standard 24 Hr. Fire (Wireless)

- Digit 2 selects 1 of the following 6 options for Reporting Codes

Opt#	Phone Line 1	Programming Section	Phone Line 2	Programming Section
1	Disabled	[380] Opt 1 OFF	Disabled	
2	SIA automatic Reporting Codes enabled	[350] 1st Phone # [04] [380] Opt 1 ON [381] Opt 3 OFF	SIA Automatic Reporting Codes Enabled	[350] 2nd Phone # [04]
3	Contact ID Reporting Codes enabled	[350] 1st Phone # [03] [380] Opt 1 ON [381] Opt 7 OFF	SIA Automatic Reporting Codes Enabled	[350] 2nd Phone # [04] [381] Opt [03] OFF
4	SIA automatic Reporting Codes enabled	[350] 1st Phone # [04] [380] Opt 1 ON [381] Opt 3 OFF	Residential Dial Enabled	[350] 2nd Phone # [06]
5	Contact ID Reporting Codes enabled	[350] 1st Phone # [03] [380] Opt 1 ON [381] Opt 7 OFF	Residential Dial Enabled	[350] 2nd Phone # [06]
6	Contact ID Reporting Codes enabled	[350] 1st Phone # [03] [380] Opt 1 ON [381] Opt 7 OFF	Contact ID Reporting Codes Enabled	[350] 2nd Phone # [03]

- **Digit 3** selects 1 of the 8 following options

Option	Common Group	Selected Troubles	Openings/ Closings	Zone Restorals	DLS/Installer Lead In/Out
1	✓			✗	✗
2	✓	✓		✗	✗
3	✓		✓	✗	✗
4	✓	✓	✓	✗	✗
5	✓	✓			✗
6	✓		✓		✗
7	✓	✓	✓		✗
8	✓				

✓ indicates included, Blank indicates default setting, ✗ indicates disabled

- **Common Group** - Sets all Reporting Codes to Automatic

Description	Phone 1	Phone 2	Sections
Set all Reporting Codes to automatic			[320] - [348] FF
Alarm/Restore call directions enabled	✓	✗	[351][1] ON, [2] OFF
Tamper/Restore Call directions disabled	✗	✗	[359][1] OFF, [2] OFF
Opening/Closing Call directions disabled	✗	✗	[367][1] OFF, [2] OFF
Maintenance Call Directions enabled	✓	✗	[375][1] ON, [2] OFF
Test Transmission Call directions disabled	✗	✗	[376][1] OFF, [2] OFF

- **Selected Troubles** - Enables the following Troubles

Trouble	[345] Alarms	[346] Restoral
Battery	FF	FF
AC Failure	00	00
Fire Trouble	FF	FF
Aux PS	FF	FF
TLM	XX	00
General System	00	00

FF = Communicate in automatic format, 00 = Disabled, XX = Not Transmitted

- **Openings & Closings** - Sets Residential Dial Reporting Codes for all openings and closings

Users	CLOSINGS, Residential Dial Reporting codes								Section
1-8	51	52	53	54	55	56	57	58	[339]
9-16	61	62	63	64	65	66	67	68	[339]
40	99	FF	FF	FF	FF	XX	XX	XX	[341]

Users	OPENINGS, Residential Dial Reporting codes								Section
1-8	11	12	13	14	15	16	17	18	[342]
9-16	21	22	23	24	25	26	27	28	[342]
40	98	FF	XX	XX	XX	XX	XX	XX	[344]
Enable Opening/Closings call directions for Phone 2 FF=Communicates in Automatic Mode, XX=Not Used									[367]Opt 2 ON

• **Installer Lead-in/Lead-out and DLS Lead-in/Lead-out**

DLS Lead In	DLS Lead Out	Installer Lead Out	Installer Lead In
Sect [347] Opt 4	Sect [347] Opt 5	Sect [347] Opt 11	Sect [347] Opt 12
Disabled for all Template Options except Option 8			

Digit 4 indicates/selects 1 of the 3 following DLS Connections

Option	Double Call	Call Back	#Rings
	Sect [401] Opt 1	Sect [401] Opt 3	Sect [406] Opt 3
1	✘	✘	0
2	✔	✘	8
3	✔	✔	8

After the 4th digit is entered you will be prompted to enter the following Data.
Refer to Section 8 for additional programming functions.

Entry 5	Central Station Telephone Number - Enter 32 Character Telephone number - See Section [301] for details.
Entry 6	Central Station Account Code - Enter the 6-digit code - See Section [310] for details.
Entry 7	DLS Access Code - Enter the 6-digit code - See Section [403] for details.
Entry 8	Entry Delay1, Exit Delay - Enter Entry Delay1, Exit Delay - See Section [005] entries [1], [3] for details.
Entry 9	Installer Code - Enter a 4 or 6-digit entry depending on setting of Section [701] Opt 5 - See Section [006] for details.

Section 4: DLS Programming

4.1 Local Programming with PC-Link

Follow the steps below in the sequence indicated to set up local programming using DLS:

New Installations (Refer to section 1.1 Installation on page 2)

1. Connect the AC Wiring before mounting the back plate.

i *In a new installation the backup battery requires 24 Hrs. charging.
AC Power is required for PC-Link Programming until battery is charged.*

2. Secure the front cover to the backplate

3. Connect the PC-Link cable between the Computer with DLS Software installed and the header pins on the alarm panel to be programmed.

i *Connecting the DLS PC to the system will automatically initiate the connection.*

4. When programming has been completed remove the PC-Link cable and the front cover from the backplate

5. Complete the installation

Existing Installations (Refer to section 1.1 Installation on page 2)

1. Remove the front plate and place it into the third hand – keeping the battery connected. See Figure 3, Third Hand

Figure 3, Third Hand

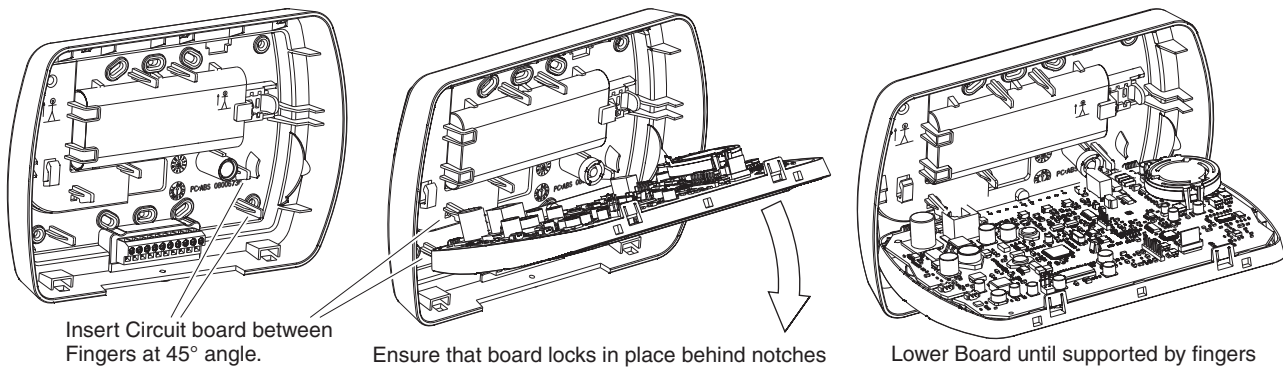

2. Place the PC-Link cable on the header pins and the downloading session will occur.

3. Upon completion of the session remove the PC-Link cable.

4. Remove the front plate from the third hand and secure it to the back plate.

4.2 Remote Programming (via telephone line)

Refer to Section “[401] Downloading Options” on page 25 and page 40 for details.

i *AC Power must be present for the Alarm system to answer Incoming calls from DLS*

Section 5: Operation

The LCD keypad displays the description and status indicator lights represent alarm functions and status. This section describes basic keypad commands. Refer to the User Guide for detailed descriptions of all keypad commands.

 *Press the [#] key to reset the keypad if an error has been made entering user codes or keypad commands*

5.1 – Away Arming

The Ready light must be **ON** to arm the system. If the Ready light is **OFF**, ensure all protected doors and windows are secure or bypassed. To arm the system in the Away mode, either press and hold the Away function button for 2 seconds or enter a valid user code and leave the premises through a door programmed as Delay. Upon pressing a function key or entering an access code, the Armed light will turn **ON**. If the Audible Exit Delay option is enabled, the keypad will beep once every second during the exit delay (and three times a second during the last 10 seconds) to alert the user to leave. The Ready light will turn off when the **Exit Delay** ends.

5.2 – Stay Arming

The Ready light must be **ON** to arm the system. If the Ready light is **OFF** ensure all protected doors and windows are secure or bypassed. To arm the system in the Stay mode, either press and hold the Stay function button for 2 seconds or enter a valid user code and stay within the premises (do **NOT** violate a door programmed as Delay). Upon pressing a function key or entering an access code, the Armed light will turn **ON**. If the Stay function button is used, the keypad will not beep during the exit delay to avoid annoying the person staying in the premises. If a user code was used, the keypad will beep if the **Audible Exit Delay** option is enabled. The Ready light will turn off when the **Exit Delay** ends.

5.3 – Disarming

The user must enter through a door programmed as Delay. Upon entering, the keypad will emit a steady tone (and emit a pulsing tone during the last 10 seconds of entry delay) to alert the user to disarm the system. Enter a valid user code to disarm the system. If an alarm occurred while the panel was armed, the keypad will display '**Alarm in Memory**'. Press the [#] key to return the keypad to the Ready state.

5.4 – [*] Commands

The following is a list of the [*] commands available and a description of each:

[*][1]	Bypass (disarmed state)/Reactivate Stay/Away Zones (armed state)
[*][2]	Display Trouble Conditions
[*][3]	Display Alarm Memory
[*][4]	Door Chime Enable/Disable
[*][5]	User Code Programming
[*][6]	User Commands
[*][7][x]	Command Functions 1 – 2
[*][8]	Installer Programming
[*][9][code]	No-Entry Arming
[*][0]	Quick Arm (disarmed state)/Quick Exit (armed state)

[*][1] – Bypass/Re-activate Stay/Away and Night Zones

Press [*][1] to enter the bypass mode. If the Code Required for Bypass option is enabled, enter a valid user code. The keypad will display 'Scroll to View Zones'. The keypad will display the programmed zone labels for the zones and include the letter 'O' in the bottom, right corner if the zone is violated or the letter 'B' if the zone is bypassed. Scroll to the appropriate zone and press the [*] key to change the bypass status (or enter the 2-digit zone number). Once the correct zones are bypassed, press [#] to exit.

Additional Bypass Commands:

Bypass Recall:	Press [99]. The keypad will recall the last group of zones that were bypassed
Clear Bypass:	Press [00]. The keypad will clear the bypass on all zones.
Save Bypass:	Press [95]. The keypad will save which zones are manually bypassed.
Recall Save:	Press [91]. The keypad will recall the bypassed zones that were saved.

Re-activate Stay/Away and Night Zones:

Press [*][1] when the system is armed in the Stay mode to change the armed status to Away mode or Night mode. The system will add the Stay/Away zones back into the system after the exit delay time expires.

 *If any zones are programmed as Night Zones (zone definition 37) pressing [*][1] will activate the Night mode instead of Away mode.*

[*][2] – Trouble Display

Refer to *Appendix E: Troubleshooting Guide*, for troubleshooting assistance and a detailed description of all trouble conditions.

[*][3] – Alarm Memory Display

Pressing the scroll <> keys will display an “Alarms in Memory” message if an alarm occurred during the last armed period. Pressing [*][3] will display the message “Scroll to view Alarms”. Scrolling will display the zones that went into alarm. To clear the Memory, arm then disarm the system.

[*][4] – Door Chime Enable/Disable

Press [*][4]. The keypad will emit 3 rapid beeps to indicate that the door chime feature is now enabled and a steady 2-second tone if it is now disabled. The same function can be performed by pressing and holding the Chime function button for 2 seconds.

[*][5] – Program User Codes

The following table identifies available user codes:

Code	Type	Function
[01] – [16]	General User Codes	Arm, disarm, attribute functions
[40]	Master Code	All functions, arm, disarm, program user codes

Programming User Codes:

Press [*][5] followed by the Master Code. The keypad will display the first user (user 01) and include the letter ‘P’ if the user code is programmed. Scroll to the appropriate user and press the [*] key to program the user (or enter the 2-digit user number). Enter a new 4 or 6-digit user code or press [*] to delete the user code. After the user code is programmed or deleted, scroll to another user or press [#] to exit.

Programming User Attributes:

Press [*][5] followed by the Master Code or Supervisor Code. Press [9] followed by the 2-digit user to change to the user attributes.

- [1] Supervisor’s Code
This attribute makes the code valid when entering the [*][5] User Code Programming section and [*][6] User Functions. Note, these codes can only program codes which have equal or lesser attributes. This attribute will also allow this user to create bypass groups if an access code is required to enter into [*][1] Bypassing.
- [2] Duress Code
Duress codes are standard user codes that will transmit the Duress Reporting Code whenever the code is entered to perform any function on the system.
- [3] User can manually bypass zones if Bypassing requires an access code.
- [4]-[6] Future Use
- [7] The panel will squawk the bell output when the user arms or disarms when in Away Armed mode.
- [8] One-time Use Code
The One-time-use Code allows unlimited arming but only permits a single disarming once a day.
The Disarm function is restored at midnight.

To change the user attributes, press the number corresponding to the attribute or scroll to the desired attribute and press [*]. When the correct attributes are assigned to the user, press [#] to exit. To change the user attributes for another user, press [9] followed by the 2-digit user number. When finished, press [#] to exit.



These attributes affect the operation of wireless keys



Duress codes are not valid when entering [][5], [*][6] or [*][8] sections and will transmit a duress alarm.
Duplicate codes and codes that are +/- 1 of an existing code can not be programmed.*

[*][6] – User Functions

Press [*][6] followed by the Master Code, then press the number corresponding to the following functions or scroll to the desired option, then press [*].

- [1] **Program Time and Date:** Enter the time and date using the following format [HH:MM] [MM/DD/YY]. Program the time using military standard (e.g., 8:00 pm = 20:00 hours).
- [2]-[3] **Future Use**

- [4] **System Test:** The panel will activate the keypad buzzer, LCD pixels and all keypad status lights for 2 seconds followed by 2 seconds of full volume alarm, then transmit a reporting code to the central station (if programmed).
- [5] **Enable DLS:** The panel will temporarily enable DLS double-call for 6 hours.
- [6] **User Initiated DLS:** The panel will attempt to call the DLS computer.
- [7] **Future Use**
- [8] **User Walk Test Mode:** The panel will switch into User Walk Test Mode. The panel will display the base mode menu.

Additional Keypad Functions:

When scrolling through the list of available functions, the following additional functions are available:

Event Buffer:	Used to view the 128-event panel buffer
Brightness Control:	Used to adjust the display backlighting level for optimal viewing
Contrast Control:	Used to adjust the display contrast level for optimal viewing
Buzzer Control:	Used to adjust the keypad buzzer tone for optimal sound

[*][7][x] – Command Outputs (1&2)

Press [*][7][x]. If the Command Output Code Required option is enabled, enter a valid user code. The panel will activate any PGM output assigned to the command output.

[*][8] – Installer Programming

Press [*][8][Installer Code] to enter Installer Programming. Installer programming allows the installer to program all system functions. Refer to the *Section 6: Advanced Programming* for details.

[*][9][User Code] – No-Entry Arming

Press [*][9] followed by a valid user code. The system will arm in the Stay mode and after the exit delay expires, it will remove entry delay. All zones programmed as Delay will function like Instant zones. The system will flash the Armed light to indicate that the system is armed with no entry delay.

[*][0] – Quick Arm/Quick Exit

Quick Arm: When disarmed, press [*][0] to arm the system. The system will arm as if a valid user code was entered.

Quick Exit: When armed, press [*][0] to activate Quick Exit. The system will allow a single zone programmed as Delay to be violated once during the following 2 minute time period without changing the status of the system.

5.5 Function Keys

The keypad has 5 programmable one-touch function keys located in a column down the right-side of the keypad. These keys can also be activated by pressing and holding number [1] through [5] respectively for 2 seconds. The default for these keys are as follows:

[1] Stay Arm	[4] Bypass
[2] Away Arm	[5] Quick Exit
[3] Chime Enable/Disable	

Section 6: Advanced Programming

This section provides the information necessary to program all required features for a basic system as well as common applications.

6.1 How to Program:

DSC recommends filling in the Programming Worksheet with the required programming information before programming the system. This will reduce the time required to program and will help eliminate errors.

To enter Installer Programming press **[*][8][Installer Code]**. The LCD keypad will display **'Enter Section'**. An error tone indicates the installer code entered is incorrect. Press **[#]** to clear any key presses and try again.

 *The default Installer Code is [5555].*

The Armed and Ready lights indicate programming status:

Armed Light ON	Panel waiting for 3-digit section number
Ready Light ON	Panel waiting for data to be entered
Ready Light FLASHING	Panel waiting for HEX data to be entered

 *You cannot enter installer programming while the system is armed or in alarm.*

6.2 Programming Toggle Options:

Enter the 3-digit programming section number

Option ON	Option OFF
# Displayed	Dash [-] Displayed

- The Armed light will turn **OFF** and the Ready light will turn **ON**.
- The keypad will display which toggle options are **ON** or **OFF** according to the chart.
- To toggle an option **ON** or **OFF**, press the corresponding number on the keypad. The display will change accordingly.
- When all the toggle options are configured correctly, press the **[#]** key to exit the program section.
- The Ready light will turn **OFF**, the Armed light will turn **ON** and the LCD will display **"Enter Section"**.

6.3 Programming Decimal and Hexadecimal (HEX) Data:

- Enter the 3-digit programming section number.
- The Armed light will turn **OFF** and The Ready light will turn **ON**.
- Enter the data written in the boxes.

For sections that require multiple 2 or 3 digit numbers, the keypad will double-beep after each 2 or 3 digit entry and move to the next item in the list. After the last digit in the section is entered, the keypad will beep rapidly 5 times and exit the program section. The Ready light will turn **OFF**, the Armed light will turn **ON** and the LCD will display **"Enter Section"**.

For sections that do not require data for every box (such as phone numbers) press the **[#]** key to exit the program section after entering all the required data. The Ready light will turn **OFF**, the Armed light will turn **ON** and the LCD will display **"Enter Section"**.

At any time the **[#]** can be pressed to exit any program section. All changes made up to that point will be saved.

 *In addition to the standard digits 0-9, HEX digits and special dialer functions can also be programmed.*

To enter a HEX digit, press the **[*]** key to begin HEX programming. The Ready light will FLASH. Press the number corresponding to the HEX digit required. The Ready light will continue to FLASH. Press **[*]** again to return to normal decimal programming. The Ready light will turn **ON**.

Value	Enter	Telephone Dialer
HEX [A]	Press [*][1][*]	Not Supported
HEX [B]	Press [*][2][*]	Simulated [*] key
HEX [C]	Press [*][3][*]	Simulated [#] key
HEX [D]	Press [*][4][*]	Dial tone search
HEX [E]	Press [*][5][*]	Two second pause
HEX [F]	Press [*][6][*]	Not Supported

6.4 How to Exit Installer Programming:

To exit installer programming, press the **[#]** key when the panel is waiting for a 3-digit section number (the Armed light is **ON**). The LCD will display the user menu.

6.5 Viewing Programming

The keypad will immediately display all the information programmed when a programming section is entered. Use the arrow keys (< >) to scroll through the data being displayed. Scroll past the end of the data displayed, or press the **[#]** key to exit the section.

Section 7: Programming Work Sheets

7.1 Index to Programming Work Sheets and Descriptions

Programming Option.....	PWS/Desc.	Programming Option (cont.).....	PWS/Desc.
[000] Keypad Function Key Programming.....	16/33	[380] First Communicator Options.....	24/39
[001]-[002] Zone Definitions.....	16/33	[381] Second Communicator Options.....	25/40
[005] System Times.....	17/34	[382] Third Communicator Options.....	25/40
[006] Installer's Code.....	17/34	[401] Downloading Options.....	25/40
[007] Master Code.....	17/34	[402] DLS Downloading Telephone Number.....	25/41
[009] I/O Programming.....	17/34	[403] Downloading Access Code.....	25/41
[012] Keypad Lockout Options.....	17/34	[404] Panel Identification Code.....	25/41
[013] First System Options.....	17/35	[406] Number of Rings to Answer On.....	26/41
[014] Second System Options.....	18/35	[499] Initiate PC Link Downloading.....	26/41
[015] Third System Options.....	18/35	[501]-[502] PGM Output Attributes.....	26/41
[016] Fourth System Options.....	18/36	[600] 2-way Audio Control Options.....	27/42
[023] Tenth System Options.....	18/36	[700] Automatic Clock Adjust.....	27/42
[030] Zone Loop Response Options.....	19/37	[701] First International Options.....	27/43
[101]-[134] Zone Attributes.....	19/37	[702] Second International Options.....	27/43
[168] Set Clock Forward (Daylight Saving Time).....	20/37	[703] Delay Between Dialing Attempts.....	27/43
[169] Set Clock Back (Standard Time).....	20/37	[804] Wireless Programming.....	28/43
[170] PGM Output Timer.....	20/38	[01]-[32] Wireless Zone Programming.....	28/43
[176] Cross Zone/Police Code Timer.....	20/38	[41]-[56] Wireless Key Programming.....	28/43
[190] No Activity Arming Pre-Alert Timer.....	20/38	[60]-[76] Wireless Key Function Key Programming.....	28/43
[191] No Activity Arming Timer.....	20/38	[81] Wireless Supervisory Window.....	28/43
[202]-[206] Zone Assignments.....	20/38	[82]-[85] Zone Transmitter Supervision.....	29/44
[301] First Telephone Number.....	20/38	[90] General Wireless Options.....	29/44
[302] Second Telephone Number.....	20/38	[898] Wireless Device Enrollment.....	29/44
[303] Third Telephone Number.....	20/38	[899] Template Programming.....	29/44
[304] Call Waiting Cancel String.....	20/38	[900] Panel Version Displayed.....	29/44
[310] System Account Code.....	20/38	[904] Wireless Module Placement Test.....	29/44
[320]-[322] Alarm Reporting Codes.....	21/38	[990] Installer Lockout Enable.....	29/44
[324]-[326] Alarm/Restoral Reporting Codes.....	21/38	[991] Installer Lockout Disable.....	29/44
[328] Misc. Alarm Reporting Codes.....	21/38	[996] Restore Wireless Device Default Programming.....	29/44
[329] Priority Alarm And Restoral Reporting Codes.....	21/38	[998] Restore Control Panel Default Programming.....	29/44
[330]-[332] Tamper Reporting Codes.....	22/38	[999] Restore System Default Programming.....	29/44
[334]-[336] Tamper Restoral Reporting Codes.....	22/38	Local Keypad Programming.....	30/45
[338] Misc. Tamper Reporting Codes.....	22/38	[001]-[034] Zone Label Programming.....	30/45
[339] Closing (Arming) Reporting Codes (Access Codes).....	22/38	[065] Fire Alarm Label.....	31/45
[341] Misc. Closing (Arming) Reporting Codes.....	22/38	[066] Fail to Arm Event Message.....	31/45
[342] Opening (Disarming) Reporting Codes (Access Codes).....	22/38	[067] Alarm When Armed Event Message.....	31/45
[344] Misc. Opening (Disarming) Reporting Codes.....	22/38	[068] Command Output #1 Label.....	31/45
[345] Maintenance Alarm Reporting Codes.....	23/38	[069] Command Output #2 Label.....	31/45
[346] Maintenance Restoral Reporting Codes.....	23/38	[074] First Keypad Options.....	32/46
[347] Misc. Maintenance Reporting Codes.....	23/38	[075] Second Keypad Options.....	32/46
[348] Test Transmission Reporting Codes.....	23/38	[076] Third Keypad Options.....	32/47
[350] Communicator Format Options.....	23/38	[077] Programmed LCD Message.....	32/47
[351] Alarm/Restore Comm. Call Directions.....	23/38	[078] Programmed LCD Message Duration.....	32/47
[359] Tamper/Restore Comm. Call Directions.....	23/38	[201]-[234] Door Chime Options.....	32/47
[367] Opening/Closing Comm. Call Directions.....	23/38	[996] Reset Programmable Labels to Factory Defaults.....	32/47
[375] System Maintenance Comm. Call Directions.....	24/38		
[376] System Test Transmission Comm. Call Directions.....	24/38		
[377] Communication Variables.....	24/39		
[378] Test Transmission Time of Day.....	24/39		

7.2 Programming Worksheets

i Unless indicated otherwise, default values apply to NA, EU and CP-01
SIA FAR CP-01 defaults are indicated in gray text.

EU Defaults are indicated by a Superscript EU e.g., (^{EU}✓) or (^{EU}005)

NA Defaults are indicated by a Superscript NA e.g., (^{NA}✓) or (^{NA}005)

Keypad and Function Key Programming

i See “Local Keypad Programming” on page 30. for additional options.

[000] Function Key Programming

- [1] Function Key 1 Assignment
- [2] Function Key 2 Assignment
- [3] Function Key 3 Assignment
- [4] Function Key 4 Assignment
- [5] Function Key 5 Assignment

Function Key Options:

- | | | |
|---------------------------------|---|--|
| 00 Null Key | 09 Future Use | *27 Disarm |
| 01 Future Use | 10 Future use | *29 [A] uxilliary Alarm |
| 02 Future Use | 11 Future use | *30 [P] anic |
| 03 Stay Arm | 12 Future Use | |
| 04 Away Arm | 13 [*][7][1] Command Output #1 | * Applies to Key Fobs only |
| 05 [*][9] No Entry Arm | 14 [*][7][2] Command Output #2 | See Section [804] Subsection [61]-[76] |
| 06 [*][4] Chime On / Off | 15 For Future Use | |
| 07 Future Use | 16 [*][0] Quick Exit | |
| 08 [*][1] Bypass Mode | 17 [*][1] Reactivate Stay/Away Zones | |

	Key 1	Key 2	Key 3	Key 4	Key 5
Keypad Defaults	03 ____	04 ____	06 ____	08 ____	16 ____

[001]-[002] Zone Definitions

- | | | |
|---|---|--|
| 00 Null Zone (Not Used) | 13 24 Hour Gas* | 25 Interior Delay* |
| 01 Delay 1* | 14 24 Hour Heat* | 26 24 Hour Non-alarm* |
| 02 Delay 2* | 15 24 Hour Medical* | 27-31 Future Use |
| 03 Instant* | 16 24 Hour Panic* | 32 Instant Stay/Away* |
| 04 Interior* | 17 24 Hour Emergency* | 33-35 Future Use |
| 05 Interior, Stay/Away* | 18 Future Use | 36 24 Hr. Non-latching Tamper |
| 06 Delay, Stay/Away* | 19 24 Hour Water* | 37 Night Zone |
| 07-08 Future Use | 20 24 Hour Freeze* | 87 Delayed 24 Hr. Fire (Wireless)** |
| 09 24 Hour Supervisory (Hardwired) | 21 Future Use | 88 Standard 24 Hr. Fire (Wireless)** |
| 10 24 Hour Supervisory Buzzer* | 22 Momentary Keyswitch Arm* | 89 Auto-verified 24 Hr. Fire (Wireless)** |
| 11 24 Hour Burglary* | 23 Maintained Keyswitch Arm (Hardwired)* | |
| 12 Future Use | 24 Future Use | |

*For burglary applications only

** For residential fire applications only

Section	Zone	Default	Section	Zone	Default	Section	Zone	Default	Section	Zone	Default
[001]	01	01	[001]	09	00	[002]	17	00	[002]	25	00
	02	03		10	00		18	00		26	00
	03	03		11	00		19	00		27	00
	04	03		12	00		20	00		28	00
	05	04		13	00		21	00		29	00
	06	04		14	00		22	00		30	00
	07	04		15	00		23	00		31	00
	08	04		16	00		24	00		32	00

[005] System Times

Valid entries for Entry Delay are between 030-255, valid entries for SIA CP-01 Exit Delay is between 045-255.

030 Entry Delay 1
 045 Entry Delay 2
 120 Exit Delay
 004 Bell Cut-off

i For SIA CP-01 compliant installations, the Exit Delay must be within the range of 045-255 seconds (Default 60 seconds). If the Exit Delay is silent (Section 14, Option 6 or Stay Function Key Arming) the exit delay must be twice the programmed value but must not exceed 255 seconds (i.e., 090-255 seconds).

i For UL Installations, the Entry Delay plus the Communications Delay must not exceed 60 seconds.

[006] Installer's Code

Default

5555 **[007] Master Code**

Default

1234 **Programmable Output Options**

00	Null PGM (Not Used)	10	System Event Output (with Event Options)
01	Residential Burglary and Fire Bell Output	11	System Tamper (all sources: zones, keypad)
02-04	Future Use	12	TLM and Alarm
05	System Armed Status	13-16	Future Use
06	Ready To Arm	17	Away Armed Status
07	Keypad Buzzer Follower	18	Stay Armed Status
08	Courtesy Pulse	19	Command Output #1 ([*][7][1])
09	System Trouble Output (with Trouble Options)	20	Command Output #2 ([*][7][2])

[009] I/O Programming

i Program Zone Definition Attributes in Sections [133-134], Program PGM Option Attributes in sections [501] - [502]

Default

00 I/O Type (Zone 33, PGM 1) Enter Zone Definition or PGM Definition
 00 I/O Type (Zone 34, PGM 2) Enter Zone Definition or PGM Definition

[012] Keypad Lockout Options

i If Keypad Lockout is active, the panel cannot be disarmed with a keyswitch.

Default

000 Number of Invalid Codes Before Lockout (Valid entries are 000-255)
 000 Lockout Duration (in minutes) (Valid entries are 000-255)

[013] First System Options

Opt	Def.	ON	OFF
1	✓	<input type="checkbox"/> Hardwired Zone 33 Input Enabled	<input type="checkbox"/> PGM1 Output Enabled
2	✓	<input type="checkbox"/> Hardwired Zone 34 Input Enabled	<input type="checkbox"/> PGM2 Output Enabled
3-5		<input type="checkbox"/> Future Use	✓ <input type="checkbox"/>
6	✓	<input type="checkbox"/> Audible Exit Fault Enabled	<input type="checkbox"/> Audible Exit Fault Disabled
7	✓	<input type="checkbox"/> Event Buffer follows Swinger Shutdown	<input type="checkbox"/> Event Buffer Logs Past Shutdown
8		<input type="checkbox"/> Temporal Three Fire Signal Enabled	✓ <input type="checkbox"/> Standard Pulsed Fire Signal

[014] Second System Options

Opt	Def.	ON	OFF
1	<input type="checkbox"/>	Arm/Disarm Bell Squawk Enabled	✓ <input type="checkbox"/> Arm/Disarm Bell Squawk Disabled
2	<input type="checkbox"/>	Future Use	✓ <input type="checkbox"/>
3	<input type="checkbox"/>	RF Jam Log After 5 Minutes	✓ <input type="checkbox"/> RF Jam Logs After 20 seconds
4	<input type="checkbox"/>	Aux Boost Enabled	✓ <input type="checkbox"/> Aux Boost Disabled
5	<input type="checkbox"/>	Future Use	✓ <input type="checkbox"/>
6	✓ <input type="checkbox"/>	Audible Exit With Urgency	<input type="checkbox"/> Silent Exit Delay
7	<input type="checkbox"/>	Future Use	✓ <input type="checkbox"/>
8	<input type="checkbox"/>	Fire Bell is Continuous	✓ <input type="checkbox"/> Fire Bell Follows Bell Cut-off

[015] Third System Options

Opt	Def.	ON	OFF
1	✓ <input type="checkbox"/>	[F] Key Enabled	<input type="checkbox"/> [F] Key Disabled
2	<input type="checkbox"/>	[P] Key Audible (Bell/Beeps)	✓ <input type="checkbox"/> [P] Key Silent
3	<input type="checkbox"/>	Quick Exit Enabled	✓ <input type="checkbox"/> Quick Exit Disabled
4	✓ <input type="checkbox"/>	Quick Arming Enabled ([*][0] and Function Keys)	<input type="checkbox"/> Quick Arming Disabled (Function Key Requires Code)
5	<input type="checkbox"/>	Code Required for Bypassing	✓ <input type="checkbox"/> No Code Required
6	<input type="checkbox"/>	Master Code not Changeable	✓ <input type="checkbox"/> Master Code Changeable
7	✓ <input type="checkbox"/>	TLM Enabled	<input type="checkbox"/> TLM Disabled
8	<input type="checkbox"/>	System Tamper Enabled	✓ <input type="checkbox"/> System Tamper Disabled

[016] Fourth System Options

Opt	Def.	ON	OFF
1	<input type="checkbox"/>	Cross Zoning Enabled	✓ <input type="checkbox"/> Police Code enabled
2	✓ <input type="checkbox"/>	Exit Delay Restart Enabled (required for CP-01)	✓ <input type="checkbox"/> Exit Delay Restart Disabled
3	<input type="checkbox"/>	Blank Keypad When Not Used	✓ <input type="checkbox"/> Keypad Always Active
4	<input type="checkbox"/>	Code Required to Remove Keypad Blanking	✓ <input type="checkbox"/> No Code Required
5	✓ <input type="checkbox"/>	Keypad Backlighting Enabled	<input type="checkbox"/> Keypad Backlighting Disabled
6	✓ <input type="checkbox"/>	ID WKEY Not required for Disarming	<input type="checkbox"/> ID WKEY Required for Disarming
7	<input type="checkbox"/>	Bypass Status Displayed While Armed	✓ <input type="checkbox"/> Bypass Status Not Displayed While Armed
8	<input type="checkbox"/>	Daylight Saving Time Enabled	✓ <input type="checkbox"/> Daylight Saving Time Disabled

[023] Tenth System Options

Opt	Def.	ON	OFF
1	<input type="checkbox"/>	[F] Key Beeps Only	✓ <input type="checkbox"/> [F] Key Beeps and Sounds Bell
2	<input type="checkbox"/>	Future Use	✓ <input type="checkbox"/>
3	<input type="checkbox"/>	Test Transmission while Armed Only	✓ <input type="checkbox"/> Test Transmission while Armed/Disarmed
4	<input type="checkbox"/>	Test Transmission Counter in Hours	✓ <input type="checkbox"/> Test Transmission Counter in Days
5	<input type="checkbox"/>	Switching from Away to Stay Disabled	✓ <input type="checkbox"/> Away to Stay Toggle Option Permitted
*6	✓ <input type="checkbox"/>	New Alarms will not disconnect 2-way Audio	<input type="checkbox"/> New Alarms disconnect 2-way Audio
7	<input type="checkbox"/>	Trouble beeps are Silent	✓ <input type="checkbox"/> Trouble Beeps Sound Every 10 seconds
8	<input type="checkbox"/>	Keyswitch Arms in Away Mode	✓ <input type="checkbox"/> Keyswitch Arms in Stay or Away Mode

* Applies to SCW9047 version only. This option must be OFF for UL Listed Installations

[030] Zone Loop Response Options

Opt	Def.	ON	OFF
1	<input type="checkbox"/>	Zone 33 is Fast Loop Response	✓ <input type="checkbox"/> Zone 33 is Normal Loop Response
2	<input type="checkbox"/>	Zone 34 is Fast Loop Response	✓ <input type="checkbox"/> Zone 34 is Normal Loop Response
3-8	<input type="checkbox"/>	Future Use	✓ <input type="checkbox"/>

[101]-[134] Zone Attributes (Options 10-13 are reserved for Future Use).**Zone Attribute Defaults**

Attribute:	1	2	3	4	5	6	7	8	9	14	15	16
	Audible Silent	Steady Pulsed	Chime No	Bypass No	Force* No	Swing No	Tx. Delay No	Cross Zn No	2-way Audio No	NC Loops	SEOL	DEOL
Zone Type:												
00 Null Zone	OFF	OFF	OFF	OFF	OFF	OFF	OFF	OFF	OFF	OFF	OFF	OFF
01 Delay 1	ON	ON	ON	ON	OFF	ON	OFF	OFF	ON	OFF	ON	OFF
02 Delay 2	ON	ON	ON	ON	OFF	ON	OFF	OFF	ON	OFF	ON	OFF
03 Instant	ON	ON	ON	ON	OFF	ON	OFF	OFF	ON	OFF	ON	OFF
04 Interior	ON	ON	OFF	ON	OFF	ON	OFF	OFF	ON	OFF	ON	OFF
05 Interior Stay/Away	ON	ON	OFF	ON	ON	ON	OFF	OFF	ON	OFF	ON	OFF
06 Delayed Stay/Away	ON	ON	OFF	ON	ON	ON	OFF	OFF	ON	OFF	ON	OFF
07 Future Use	OFF	OFF	OFF	OFF	OFF	OFF	OFF	OFF	OFF	OFF	OFF	OFF
08 Future Use	OFF	OFF	OFF	OFF	OFF	OFF	OFF	OFF	OFF	OFF	OFF	OFF
09 24hr Superv. (Hardwired)	OFF	ON	OFF	OFF	ON	OFF	OFF	OFF	OFF	OFF	ON	OFF
10 24hr Superv. Buzzer	OFF	ON	OFF	ON	OFF	OFF	OFF	OFF	ON	OFF	ON	OFF
11 24hr Burglary	ON	ON	OFF	ON	OFF	OFF	OFF	OFF	ON	OFF	ON	OFF
12 Future Use	OFF	OFF	OFF	OFF	OFF	OFF	OFF	OFF	OFF	OFF	OFF	OFF
13 24hr Gas	ON	OFF	OFF	OFF	OFF	OFF	OFF	OFF	ON	OFF	ON	OFF
14 24hr Heat	ON	OFF	OFF	OFF	OFF	OFF	OFF	OFF	OFF	OFF	ON	OFF
15 24hr Medical	ON	ON	OFF	OFF	OFF	OFF	OFF	OFF	ON	OFF	ON	OFF
16 24hr Panic	ON	ON	OFF	OFF	OFF	OFF	OFF	OFF	ON	OFF	ON	OFF
17 24hr Emergency	ON	ON	OFF	OFF	OFF	OFF	OFF	OFF	ON	OFF	ON	OFF
18 Future Use	OFF	OFF	OFF	OFF	OFF	OFF	OFF	OFF	OFF	OFF	OFF	OFF
19 24hr Water	ON	ON	OFF	OFF	OFF	OFF	OFF	OFF	ON	OFF	ON	OFF
20 24hr Freeze	ON	ON	OFF	OFF	OFF	OFF	OFF	OFF	ON	OFF	ON	OFF
21 Future Use	OFF	OFF	OFF	OFF	OFF	OFF	OFF	OFF	OFF	OFF	OFF	OFF
22 Momentary Keyswitch Arm	OFF	OFF	OFF	OFF	ON	OFF	OFF	OFF	OFF	OFF	ON	OFF
23 Maintained Keyswitch (Hardwired)	OFF	OFF	OFF	OFF	ON	OFF	OFF	OFF	OFF	OFF	ON	OFF
24 Future Use	OFF	OFF	OFF	OFF	OFF	OFF	OFF	OFF	OFF	OFF	OFF	OFF
25 Interior Delay	ON	ON	OFF	ON	OFF	OFF	OFF	OFF	ON	OFF	ON	OFF
26 24hr Non-alarm	OFF	OFF	OFF	OFF	ON	OFF	OFF	OFF	OFF	OFF	ON	OFF
27-31 Future Use	OFF	OFF	OFF	OFF	OFF	OFF	OFF	OFF	OFF	OFF	OFF	OFF
32 Instant Stay/Away	ON	ON	OFF	ON	OFF	ON	OFF	OFF	ON	OFF	ON	OFF
33 Future Use	OFF	OFF	OFF	OFF	OFF	OFF	OFF	OFF	OFF	OFF	OFF	OFF
34 Future Use	OFF	OFF	OFF	OFF	OFF	OFF	OFF	OFF	OFF	OFF	OFF	OFF
35 Future Use	OFF	OFF	OFF	OFF	OFF	OFF	OFF	OFF	OFF	OFF	OFF	OFF
36 24hr Non-latching Tamper	OFF	ON	OFF	OFF	OFF	ON	OFF	OFF	OFF	OFF	ON	OFF
37 Night Zone	ON	ON	OFF	ON	ON	ON	OFF	OFF	ON	OFF	ON	OFF
87 Delay 24hr Fire (Wireless)	ON	OFF	OFF	OFF	OFF	OFF	OFF	OFF	OFF	OFF	OFF	OFF
88 Stand. 24hr Fire (Wireless)	ON	OFF	OFF	OFF	OFF	OFF	OFF	OFF	OFF	OFF	OFF	OFF
89 Auto-verified Fire (Wireless)	ON	OFF	OFF	OFF	OFF	OFF	OFF	OFF	OFF	OFF	OFF	OFF

 * For UL installations, do not change attribute 5 (Force Arming) from the default setting.

 For CP-01 installations:
 Option 6 (Swinger) is defaulted ON for zone definitions 09-11, 13-17, 19,20
 Option 7 (Tx Delay) is defaulted ON for zone definitions 01-06, 09-11, 13-17, 19,20,25,32,36,37

Daylight Saving Time

[168] Set Clock Forward (Daylight Saving Time)

Default
 003 Month Valid Entries 001-012
 EU005 NA002 Week Valid Entries 000-005
 000 Day Valid Entries 000-031
 EU001 NA002 Hour Valid Entries 000-023
 001 Increment Valid Entries 001-002

[169] Set Clock Back (Standard Time)

Default
 EU010 NA011 Month Valid Entries 001-012
 EU005 NA001 Week Valid Entries 000-005
 000 Day Valid Entries 000-031
 EU001 NA002 Hour Valid Entries 000-023
 001 Decrement Valid Entries 001-002

[170] PGM Output Timer

Default 005 Valid entries are 001-255 seconds

[176] Cross Zone/Police Code Timer

Default 060 Valid entries are 001-255 seconds/minutes

[190] No Activity Arming Pre-alert Timer

Default 001 Valid entries are 001-255 minutes, 000 for no pre-alert

[191] No Activity Arming Timer

Default 000 Valid entries are 001-255 minutes, 000 to disable

[202] - [206] Zone Assignments

	[202] Zone 1-8	[203] Zones 9-16	[204] Zones 17-24	[205] Zones 25-32	[206] Zones 33, 34
Opt	Def.	Def.	Def.	Def.	Def.
1	✓ <input type="checkbox"/> Zone 1	<input type="checkbox"/> Zone 9	<input type="checkbox"/> Zone 17	<input type="checkbox"/> Zone 25	<input type="checkbox"/> Zone 33
2	✓ <input type="checkbox"/> Zone 2	<input type="checkbox"/> Zone 10	<input type="checkbox"/> Zone 18	<input type="checkbox"/> Zone 26	<input type="checkbox"/> Zone 34
3	✓ <input type="checkbox"/> Zone 3	<input type="checkbox"/> Zone 11	<input type="checkbox"/> Zone 19	<input type="checkbox"/> Zone 27	<input type="checkbox"/> Future Use
4	✓ <input type="checkbox"/> Zone 4	<input type="checkbox"/> Zone 12	<input type="checkbox"/> Zone 20	<input type="checkbox"/> Zone 28	<input type="checkbox"/> Future Use
5	✓ <input type="checkbox"/> Zone 5	<input type="checkbox"/> Zone 13	<input type="checkbox"/> Zone 21	<input type="checkbox"/> Zone 29	<input type="checkbox"/> Future Use
6	✓ <input type="checkbox"/> Zone 6	<input type="checkbox"/> Zone 14	<input type="checkbox"/> Zone 22	<input type="checkbox"/> Zone 30	<input type="checkbox"/> Future Use
7	✓ <input type="checkbox"/> Zone 7	<input type="checkbox"/> Zone 15	<input type="checkbox"/> Zone 23	<input type="checkbox"/> Zone 31	<input type="checkbox"/> Future Use
8	✓ <input type="checkbox"/> Zone 8	<input type="checkbox"/> Zone 16	<input type="checkbox"/> Zone 24	<input type="checkbox"/> Zone 32	<input type="checkbox"/> Future Use

Communications

[301] First Telephone Number (32 Digits)

D

[302] Second Telephone Number (32 Digits)

D

[303] Third Telephone Number (32 Digits)

D

[304] Call Waiting Cancel String (6 Digits) - This feature is activated in Section 382 Opt 4

Default = DB70EF Program unused digits with Hex F

 All six digits must be entered for changes to be saved in Section [304] and Section [310]. Fill unused digit spaces with 'F'.

Account Code

Enter a 6-digit account number for the system account code. Only SIA supports 6-digit account codes. If the last two digits of the account code are FF, the panel will only use the first four digits.

Section [310] System Account Code Default [FFFFFF]

Reporting Codes

 All Reporting Codes are defaulted 'FF' unless indicated otherwise.

[320]-[322] Alarm Reporting Codes, Zones 01-34**Section**

[320]	Zone 01 _ _	Zone 02 _ _	Zone 03 _ _	Zone 04 _ _	Zone 05 _ _	Zone 06 _ _	Zone 07 _ _	Zone 08 _ _
	Zone 09 _ _	Zone 10 _ _	Zone 11 _ _	Zone 12 _ _	Zone 13 _ _	Zone 14 _ _	Zone 15 _ _	Zone 16 _ _
[321]	Zone 17 _ _	Zone 18 _ _	Zone 19 _ _	Zone 20 _ _	Zone 21 _ _	Zone 22 _ _	Zone 23 _ _	Zone 24 _ _
	Zone 25 _ _	Zone 26 _ _	Zone 27 _ _	Zone 28 _ _	Zone 29 _ _	Zone 30 _ _	Zone 31 _ _	Zone 32 _ _
[322]	Zone 33 _ _	Zone 34 _ _						

[324]-[326] Alarm Restoral Reporting Codes, Zones 01-34**Section**

[324]	Zone 01 _ _	Zone 02 _ _	Zone 03 _ _	Zone 04 _ _	Zone 05 _ _	Zone 06 _ _	Zone 07 _ _	Zone 08 _ _
	Zone 09 _ _	Zone 10 _ _	Zone 11 _ _	Zone 12 _ _	Zone 13 _ _	Zone 14 _ _	Zone 15 _ _	Zone 16 _ _
[325]	Zone 17 _ _	Zone 18 _ _	Zone 19 _ _	Zone 20 _ _	Zone 21 _ _	Zone 22 _ _	Zone 23 _ _	Zone 24 _ _
	Zone 25 _ _	Zone 26 _ _	Zone 27 _ _	Zone 28 _ _	Zone 29 _ _	Zone 30 _ _	Zone 31 _ _	Zone 32 _ _
[326]	Zone 33 _ _	Zone 34 _ _						

[328] Miscellaneous Alarm Reporting Codes

- |_|_| Duress Alarm
- |_|_| Opening After Alarm
- |_|_| Recent Closing
- |_|_| Future Use
- |_|_| Future Use
- |_|_| Cross Zone/Police Code Alarm
- |_|_| Burglary Not Verified
- |_|_| Alarm Cancelled

[329] Priority Alarm and Restoral Reporting Codes

- |_|_| Keypad [F] Fire Alarm
- |_|_| Keypad [A] Auxiliary Alarm
- |_|_| Keypad [P] Panic Alarm
- |_|_| Future Use
- |_|_| Keypad [F] Fire Restoral
- |_|_| Keypad [A] Auxiliary Restoral
- |_|_| Keypad [P] Panic Restoral
- |_|_| Future Use

[330]-[332] Tamper Reporting Codes, Zones 01-34

Section

[330]	Zone 01 _ _	Zone 02 _ _	Zone 03 _ _	Zone 04 _ _	Zone 05 _ _	Zone 06 _ _	Zone 07 _ _	Zone 08 _ _
	Zone 09 _ _	Zone 10 _ _	Zone 11 _ _	Zone 12 _ _	Zone 13 _ _	Zone 14 _ _	Zone 15 _ _	Zone 16 _ _
[331]	Zone 17 _ _	Zone 18 _ _	Zone 19 _ _	Zone 20 _ _	Zone 21 _ _	Zone 22 _ _	Zone 23 _ _	Zone 24 _ _
	Zone 25 _ _	Zone 26 _ _	Zone 27 _ _	Zone 28 _ _	Zone 29 _ _	Zone 30 _ _	Zone 31 _ _	Zone 32 _ _
[332]	Zone 33 _ _	Zone 34 _ _						

[334]-[336] Tamper Restoral Reporting Codes, Zones 01-34

Section

[334]	Zone 01 _ _	Zone 02 _ _	Zone 03 _ _	Zone 04 _ _	Zone 05 _ _	Zone 06 _ _	Zone 07 _ _	Zone 08 _ _
	Zone 09 _ _	Zone 10 _ _	Zone 11 _ _	Zone 12 _ _	Zone 13 _ _	Zone 14 _ _	Zone 15 _ _	Zone 16 _ _
[335]	Zone 17 _ _	Zone 18 _ _	Zone 19 _ _	Zone 20 _ _	Zone 21 _ _	Zone 22 _ _	Zone 23 _ _	Zone 24 _ _
	Zone 25 _ _	Zone 26 _ _	Zone 27 _ _	Zone 28 _ _	Zone 29 _ _	Zone 30 _ _	Zone 31 _ _	Zone 32 _ _
[336]	Zone 33 _ _	Zone 34 _ _						

[338] Miscellaneous Tamper Reporting Codes

- |_|_| System Tamper
- |_|_| System Tamper Restoral
- |_|_| Keypad Lockout

[339] Closing (Arming) Reporting Codes, Access Codes 1-16

Code 1 _ _	Code 2 _ _	Code 3 _ _	Code 4 _ _	Code 5 _ _	Code 6 _ _	Code 7 _ _	Code 8 _ _
Code 9 _ _	Code 10 _ _	Code 11 _ _	Code 12 _ _	Code 13 _ _	Code 14 _ _	Code 15 _ _	Code 16 _ _

[341] Miscellaneous Closing (Arming) Reporting Codes

- |_|_| Closing by Master Code 40
- |_|_| Automatic Zone Bypass
- |_|_| Partial Closing
- |_|_| Special Closing
- |_|_| Exit Fault

[342] Opening (Disarming) Reporting Codes, Access Codes 1-16

Code 1 _ _	Code 2 _ _	Code 3 _ _	Code 4 _ _	Code 5 _ _	Code 6 _ _	Code 7 _ _	Code 8 _ _
Code 9 _ _	Code 10 _ _	Code 11 _ _	Code 12 _ _	Code 13 _ _	Code 14 _ _	Code 15 _ _	Code 16 _ _

[344] Miscellaneous Opening (Disarming) Reporting Codes

- |_|_| Opening by Master Code 40
- |_|_| Special Opening

[345] Maintenance Alarm Reporting Codes

- Battery Trouble Alarm
- AC Failure Trouble Alarm
- Future Use
- Fire Trouble Alarm
- Auxiliary Power Supply Trouble Alarm
- Future Use
- General System Trouble
- Future Use

[346] Maintenance Restoral Reporting Codes

- Battery Trouble Restoral
- AC Failure Trouble Restoral
- Future Use
- Fire Trouble Restoral
- Auxiliary Power Supply Trouble Restoral
- TLM Restoral
- General System Trouble Restoral
- Future Use

[347] Miscellaneous Maintenance Reporting Codes

- Telephone Number 1 FTC Restoral
- Telephone Number 2 FTC Restoral
- Future Use
- DLS Lead IN
- DLS Lead OUT
- General Zone Fault Alarm
- General Zone Fault Restoral
- Delinquency Reporting Code
- General Zone Low Battery Alarm
- General Zone Low Battery Restoral
- Installer Lead Out
- Installer Lead In

[348] Test Transmission Reporting Codes

- Walk Test End
- Walk Test Begin
- Future Use
- Periodic Test Transmission
- System Test

[350] Communicator Format Options

Default

- 04 First Telephone Number
 - 04 Second Telephone Number
- 3rd Telephone Number follows format of First Telephone Number

- 01** 20 BPS, 1400 HZ handshake
- 02** 20 BPS, 2300 HZ handshake
- 03** DTMF CONTACT ID
- 04** SIA FSK
- 05** Pager
- 06** Residential Dial

Refer to *Appendix B: Communicator Format Options* on page 52 for details.

Call Direction Options

[351] Alarm/Restore Communicator Call Directions

Section	Option 1 First Telephone Number (Default ON)	Option 2 Second Telephone Number (Default OFF)	Option 3-8 Not Used (Default OFF)
[351]	<input type="checkbox"/>	<input type="checkbox"/>	<input type="checkbox"/>

[359] Tamper/Restore Communicator Call Directions

Section	Option 1 First Telephone Number (Default ON)	Option 2 Second Telephone Number (Default OFF)	Option 3-8 Not Used (Default OFF)
[359]	<input type="checkbox"/>	<input type="checkbox"/>	<input type="checkbox"/>

[367] Opening/Closing Communicator Call Directions

Section	Option 1 First Telephone Number (Default OFF)	Option 2 Second Telephone Number (Default OFF)	Option 3-8 Not Used (Default OFF)
[367]	<input type="checkbox"/>	<input type="checkbox"/>	<input type="checkbox"/>

[375] System Maintenance Communicator Call Directions

Section	Option 1 First Telephone Number (Default ON)	Option 2 Second Telephone Number (Default OFF)	Option 3-8 Not Used (Default OFF)
[375]	<input type="checkbox"/>	<input type="checkbox"/>	<input type="checkbox"/>

[376] System Test Transmissions Communicator Call Directions

Section	Option 1 First Telephone Number (Default ON)	Option 2 Second Telephone Number (Default OFF)	Option 3-8 Not Used (Default OFF)
[376]	<input type="checkbox"/>	<input type="checkbox"/>	<input type="checkbox"/>

[377] Communication Variables

Default

003	<input type="checkbox"/>	Swinger Shutdown (Alarms and Rest)	001-014 Transmissions
003	<input type="checkbox"/>	Swinger Shutdown (Tampers and Rest)	001-014 Transmissions, 000=disabled on Non CP-01 Systems
003	<input type="checkbox"/>	Swinger Shutdown (Maint. and Rest)	001-014 Transmissions, 000=disabled
000	<input type="checkbox"/>	Communication Delay	000-255 seconds
030	<input type="checkbox"/>	AC Failure Communication Delay	001-255 minutes/hours, 000=disabled†
EU002 NA010	<input type="checkbox"/>	TLM Trouble Delay	003-255 seconds x3 (e.g.,003 = 9 seconds)
030	<input type="checkbox"/>	Test Transmission Cycle (land line)	001-255 days/hours††
000	<input type="checkbox"/>	Future Use	
007	<input type="checkbox"/>	Zone Low Battery Transmission Delay	000-255 days
030	<input type="checkbox"/>	Delinquency Transmission Cycle	000-255 days/hours†††, 000=disabled
000	<input type="checkbox"/>	Communications Cancelled Window	000-255 minutes

†Dependent on programming in section [382], option [6]

††Dependent on programming in section [023], option [4]

†††Dependent on programming in section [380], option [8].



For UL installations, the Entry Delay plus Communication Delay time must not exceed 60 seconds.

[378] Test Transmission Time of Day

Default

9999 Valid entries are 0000-2359 (9999 to disable)

[380] First Communicator Options

Opt	Def.	ON	OFF
1	✓	<input type="checkbox"/> Communications Enabled	<input type="checkbox"/> Communications Disabled
2		<input type="checkbox"/> Restorals on Bell Time-out	✓ <input type="checkbox"/> Restorals Follow Zones
3		<input type="checkbox"/> Pulse Dialing	✓ <input type="checkbox"/> DTMF Dialing
4		<input type="checkbox"/> Future Use	✓ <input type="checkbox"/>
5		<input type="checkbox"/> Future Use	✓ <input type="checkbox"/>
6		<input type="checkbox"/> Alternate Dial (1st & 3rd)	✓ <input type="checkbox"/> Call 1st Number, Backup to 3rd
7		<input type="checkbox"/> Future Use	✓ <input type="checkbox"/>
8		<input type="checkbox"/> Delinquency Follows Zone Activity (Hours)	✓ <input type="checkbox"/> Delinquency Follows Arming (Days)

[381] Second Communicator Options

Opt	Def.	ON	OFF
1	<input type="checkbox"/>	Opening After Alarm Keypad Ringback Enabled	<input checked="" type="checkbox"/> Disabled
2	<input type="checkbox"/>	Future Use	<input checked="" type="checkbox"/>
3	<input type="checkbox"/>	SIA Uses Programmed Reporting Codes	<input checked="" type="checkbox"/> SIA Uses Automatic Reporting Codes
4	<input type="checkbox"/>	Closing Confirmation Enabled	<input checked="" type="checkbox"/> Closing confirmation Disabled
*5	<input type="checkbox"/>	Talk/Listen on Phone #1/3 Enabled	<input checked="" type="checkbox"/> Talk/Listen #1/3 Disabled
*6	<input type="checkbox"/>	Talk/Listen on Phone #2 Enabled	<input checked="" type="checkbox"/> Talk/Listen #2 Disabled
7	<input type="checkbox"/>	Contact ID Uses Programmed Reporting Codes	<input checked="" type="checkbox"/> Contact ID Uses Automatic Reporting Codes
8	<input type="checkbox"/>	Future Use	<input checked="" type="checkbox"/>

*These Options apply to SCW9047 Only. For SCW9045 default is OFF

[382] Third Communicator Options

Opt	Def.	ON	OFF
1	<input type="checkbox"/>	Contact ID Partial Closing Identifier is "5"	<input checked="" type="checkbox"/> Contact ID Partial Closing Identifier is "4"
2	<input type="checkbox"/>	Alarm Communications Enabled During Walk Test*	<input checked="" type="checkbox"/> Alarm Communications Disabled During Walk Test
3	<input type="checkbox"/>	Communication Cancelled Message Enabled (ON for SIA CP-01)	<input checked="" type="checkbox"/> Communication Cancelled Message Disabled
4	<input type="checkbox"/>	Call Waiting Cancel Enabled**	<input checked="" type="checkbox"/> Call Waiting Cancel Disabled
5	<input type="checkbox"/>	Future Use	<input checked="" type="checkbox"/>
6	<input type="checkbox"/>	AC Failure Transmission Delay is in Hours	<input checked="" type="checkbox"/> AC Failure Transmission Delay is in Minutes
7	<input type="checkbox"/>	Number of Dialing Attempts is 1 for Residential Dial	<input checked="" type="checkbox"/> Residential Dialing Attempts is 5
8	<input type="checkbox"/>	Future Use	<input checked="" type="checkbox"/>

*This option must remain OFF for SIA-FAR installations.

** A Call Waiting Cancel on a non-Call Waiting line will prevent successful connection to the central station.

DLS Downloading**[401] Downloading Options**

Opt	Def.	ON	OFF
1	<input type="checkbox"/>	Answering Machine/Double Call Enabled	<input checked="" type="checkbox"/> Answering Machine/Double Call Disabled
2	<input checked="" type="checkbox"/>	User Can Enable DLS Window	<input type="checkbox"/> User Cannot Enable DLS Window
3	<input type="checkbox"/>	Call Back Enabled	<input checked="" type="checkbox"/> Call Back Disabled
4	<input type="checkbox"/>	User Initiated Call Up Enabled	<input checked="" type="checkbox"/> User Initiated Call Up Disabled
5	<input type="checkbox"/>	Future Use	<input checked="" type="checkbox"/>
6	<input type="checkbox"/>	300 Baud Panel Call up	<input checked="" type="checkbox"/> 110 Baud Panel Call up
7	<input type="checkbox"/>	Future Use	<input checked="" type="checkbox"/>
8	<input type="checkbox"/>	Future Use	<input checked="" type="checkbox"/>

[402] DLS Downloading Telephone Number (32 Digits)

D | | | | | | | | | | | | | | | | | | | | | | | | | | | | | | | | | | | | | | | | |

[403]-[404] DLS Downloading Access Code / Panel ID Code (Enter 6 Hexadecimal Digits)

[403] Downloading Access Code

[404] Panel ID Code

SCW9045 Default = **904500/904500**

SCW9047 Default = **904700/904700**

| | | | | | | |

| | | | | | | |

Self Contained Wireless Alarm System v1.0

[406] Number of Rings To Answer On

Default 000 Valid entries are 000-009, (000 to disable)

[499] Initiate PC-Link Downloading

Enter [499] [Installer Code][499]

[501]-[502] PGM Output Attributes

Program only the following attributes for the PGM options listed. All others will be ignored.

PGM options are programmed in Section [009].

PGM Attribute Defaults (Y = Attribute ON; N = Attribute OFF):

Attribute:			1	2	3	4	5	6	7	8
	ON	OFF	Not used	Not used	True Output	Follows Timer	Code Req.	Not used	Not used	Not used
			—	—	Inverted	On / Off	No Code Req.	—	—	—
PGM Option										
[00] Null PGM (Not Used)										
[01] Residential Burglary / Fire Bell Output										
[05] System Armed Status										
[06] Ready To Arm										
[07] Keypad Buzzer follows PGM										
[08] Courtesy Pulse										
[09] System Trouble (See Table Below)	Y	Y	Y		Y	Y	Y	Y	Y	Y
[10] System Event (See Table Below)	Y	Y	Y		Y	Y	Y	Y	Y	N
[11] System Tamper (all sources, zones, keypad, modules)										
[12] TLM and Alarm										
[17] Away Armed Status										
[18] Stay Armed Status										
[19] Command Output #1, [*][7][1]										
[20] Command Output #2, [*][7][2]										

Attribute:	1	2	3	4	5	6	7	8
ON	Serv Req Evt.	AC Fail.	TLM Fault	FTC	Zone Fault	Zone Tamper	Zone Low Batt	Loss of Clock
OFF	Disabled	Disabled	Disabled	Disabled	Disabled	Disabled	Disabled	Disabled
PGM Option								
[9] System Trouble	Y	Y	Y	Y	Y	Y	Y	Y

Attribute:	1	2	3	4	5	6	7	8
ON	Burg Event	Fire Event	Panic Event	Medical Event	Supervisory Event	Priority Event	Duress Event	Follows Timer
OFF	Disabled	Disabled	Disabled	Disabled	Disabled	Disabled	Disabled	Latched
PGM Option								
[10] System Event	Y	Y	Y	Y	Y	Y	Y	N

Section	PGM #	Output Type*	1	2	3	4	5	6	7	8
Main Board										
[501]	1	()	<input type="checkbox"/>	<input type="checkbox"/>	<input type="checkbox"/>	<input type="checkbox"/>	<input type="checkbox"/>	<input type="checkbox"/>	<input type="checkbox"/>	<input type="checkbox"/>
[502]	2	()	<input type="checkbox"/>	<input type="checkbox"/>	<input type="checkbox"/>	<input type="checkbox"/>	<input type="checkbox"/>	<input type="checkbox"/>	<input type="checkbox"/>	<input type="checkbox"/>

*Record here based on programming in Section [009].

[600] 2-way Audio Control Options (Applies to SCW9047 only)

Opt	Def.	ON	OFF
1	<input type="checkbox"/>	Tampers Enabled	✓ <input type="checkbox"/> Disabled
2	<input type="checkbox"/>	Openings & Closings Enabled	✓ <input type="checkbox"/> Disabled
3	✓ <input type="checkbox"/>	[A] Key Alarm Enabled	<input type="checkbox"/> Disabled
4	✓ <input type="checkbox"/>	[P] Key Alarm Enabled	<input type="checkbox"/> Disabled
5	✓ <input type="checkbox"/>	Duress Alarm Enabled (Listen)	<input type="checkbox"/> Disabled
6	✓ <input type="checkbox"/>	Opening after Alarm Enabled	<input type="checkbox"/> Disabled
*7	<input type="checkbox"/>	Bell Active during 2-way Audio Verification.	✓ <input type="checkbox"/> Bell Silent during 2-way Audio Verification.
8	<input type="checkbox"/>	Future Use	✓ <input type="checkbox"/>

* This option must be ON for UL Listed Installations

INTERNATIONAL PROGRAMMING**[700] Automatic Clock Adjust**

Default = 60 | | Valid Entries 01-99 Seconds

[701] First International Options

Opt	Def.	ON	OFF
1	EU ✓ <input type="checkbox"/>	50 Hz AC	NA ✓ <input type="checkbox"/> 60 Hz AC
2	<input type="checkbox"/>	Time Base - Internal Crystal	✓ <input type="checkbox"/> Time Base - AC Line
3	<input type="checkbox"/>	AC/DC Arming Inhibit Enabled	✓ <input type="checkbox"/> AC/DC Arming Inhibit Disabled
4	<input type="checkbox"/>	All System Tampers Require Installer Reset	✓ <input type="checkbox"/> All System Tampers Follow Restoral
5	<input type="checkbox"/>	6-digit User Access Codes	✓ <input type="checkbox"/> 4-digit User Access Codes
6	<input type="checkbox"/>	Busy Tone Detection Enabled	✓ <input type="checkbox"/> Busy Tone Detection Disabled
7-8	<input type="checkbox"/>	Future Use	✓ <input type="checkbox"/>

[702] Second International Options

Opt	Def.	ON	OFF
1	<input type="checkbox"/>	Pulse Dialing Make/Break Ratio is 33/67	✓ <input type="checkbox"/> Pulse Dialing Make/Break Ratio is 40/60
2	✓ <input type="checkbox"/>	Force Dialing Enabled	<input type="checkbox"/> Force Dialing Disabled
3	<input type="checkbox"/>	Future Use	✓ <input type="checkbox"/>
4	<input type="checkbox"/>	1600Hz Handshake	✓ <input type="checkbox"/> Standard Handshake
5	<input type="checkbox"/>	ID Tone Enabled	✓ <input type="checkbox"/> ID Tone Disabled
6	<input type="checkbox"/>	2100 Hz ID Tone	✓ <input type="checkbox"/> 1300 Hz ID Tone
7-8	<input type="checkbox"/>	Future Use	✓ <input type="checkbox"/>

[703] Delay Between Dialing Attempts

Default = 003 | | Valid Entries are 000-255 Seconds (Entry + 5 seconds)

[804] Wireless programming

Wireless Zone Programming

Zone	Sub Section	Serial Number	Zone	Sub Section	Serial Number
1	[01]	_____	17	[17]	_____
2	[02]	_____	18	[18]	_____
3	[03]	_____	19	[19]	_____
4	[04]	_____	20	[20]	_____
5	[05]	_____	21	[21]	_____
6	[06]	_____	22	[22]	_____
7	[07]	_____	23	[23]	_____
8	[08]	_____	24	[24]	_____
9	[09]	_____	25	[25]	_____
10	[10]	_____	26	[26]	_____
11	[11]	_____	27	[27]	_____
12	[12]	_____	28	[28]	_____
13	[13]	_____	29	[29]	_____
14	[14]	_____	30	[30]	_____
15	[15]	_____	31	[31]	_____
16	[16]	_____	32	[32]	_____

Wireless Key Programming

Key#	Sub Section	Serial Number
1	[41]	_____
2	[42]	_____
3	[43]	_____
4	[44]	_____
5	[45]	_____
6	[46]	_____
7	[47]	_____
8	[48]	_____
9	[49]	_____
10	[50]	_____
11	[51]	_____
12	[52]	_____
13	[53]	_____
14	[54]	_____
15	[55]	_____
16	[56]	_____

Wireless Key Function Key Programming

Sub Section	Key 1 Default 03	Key 2 Default 04	Key 3 Default 27	Key 4 Default 30
[61]	_____	_____	_____	_____
[62]	_____	_____	_____	_____
[63]	_____	_____	_____	_____
[64]	_____	_____	_____	_____
[65]	_____	_____	_____	_____
[66]	_____	_____	_____	_____
[67]	_____	_____	_____	_____
[68]	_____	_____	_____	_____
[69]	_____	_____	_____	_____
[70]	_____	_____	_____	_____
[71]	_____	_____	_____	_____
[72]	_____	_____	_____	_____
[73]	_____	_____	_____	_____
[74]	_____	_____	_____	_____
[75]	_____	_____	_____	_____
[76]	_____	_____	_____	_____

See Function Key Options on pages 16 and 33

Wireless Supervisory Window

Sub Section	Entry x 15 minutes
[81]	Default ^{EU} 08 ^{NA} 96 _____ (i.e., ^{EU} 8 x 15 min. ^{NA} 96 x 15 min.) Value = Entry x15 minutes, Valid entries are 4 - 96 (1Hr - 24Hr)

[82]-[85] Zone Transmitter Supervision

	[82] Zone 1-8	[83] Zones 9-16	[84] Zones 17-24	[85] Zones 25-32
Opt	Def.	Def.	Def.	Def.
1	✓ <input type="checkbox"/> Zone 1	✓ <input type="checkbox"/> Zone 9	✓ <input type="checkbox"/> Zone 17	✓ <input type="checkbox"/> Zone 25
2	✓ <input type="checkbox"/> Zone 2	✓ <input type="checkbox"/> Zone 10	✓ <input type="checkbox"/> Zone 18	✓ <input type="checkbox"/> Zone 26
3	✓ <input type="checkbox"/> Zone 3	✓ <input type="checkbox"/> Zone 11	✓ <input type="checkbox"/> Zone 19	✓ <input type="checkbox"/> Zone 27
4	✓ <input type="checkbox"/> Zone 4	✓ <input type="checkbox"/> Zone 12	✓ <input type="checkbox"/> Zone 20	✓ <input type="checkbox"/> Zone 28
5	✓ <input type="checkbox"/> Zone 5	✓ <input type="checkbox"/> Zone 13	✓ <input type="checkbox"/> Zone 21	✓ <input type="checkbox"/> Zone 29
6	✓ <input type="checkbox"/> Zone 6	✓ <input type="checkbox"/> Zone 14	✓ <input type="checkbox"/> Zone 22	✓ <input type="checkbox"/> Zone 30
7	✓ <input type="checkbox"/> Zone 7	✓ <input type="checkbox"/> Zone 15	✓ <input type="checkbox"/> Zone 23	✓ <input type="checkbox"/> Zone 31
8	✓ <input type="checkbox"/> Zone 8	✓ <input type="checkbox"/> Zone 16	✓ <input type="checkbox"/> Zone 24	✓ <input type="checkbox"/> Zone 32

[90] General Wireless Options

Opt	Def	ON	OFF
1-6	<input type="checkbox"/> Future Use		✓ <input type="checkbox"/>
7	NA ✓ <input type="checkbox"/> RF Jam Disabled		EU ✓ <input type="checkbox"/> RF Jam Enabled
8	<input type="checkbox"/> Global Module Placement Test		✓ <input type="checkbox"/> Individual Module Placement Test

Special Installer Functions**[898] Wireless Device Enrollment (See Section 2)****[899] Template Programming (See Section 3)****[900] Panel Version Displayed**

____ Not Programmable (e.g. Ver. 1.0 = 0100)

[904] Wireless Module Placement Test**[990] Installer Lockout Enable**

- Enter [990][Installer Code][990]

[991] Installer Lockout Disable

- Enter [991][Installer Code][991]

[996] Restore Wireless Device Default Programming

- Enter [996][Installer Code][996]

[998] Restore Control Panel Default Programming

- Enter [998][Installer Code][998]

[999] Restore System Default Programming

- Enter [999][Installer Code][999]

Local Keypad Programming

Enter [*] when in Installer Programming to Access Keypad programming

[001]-[034] Label Programming (Zone 1-34)

		<i>Default</i>															
Zone	Sub Sect.	Z	O	N	E	X	X	Zone	Sub Sect.	XX = 01 - 34							

1	[001]							18	[018]								
2	[002]							19	[019]								
3	[003]							20	[020]								
4	[004]							21	[021]								
5	[005]							22	[022]								
6	[006]							23	[023]								
7	[007]							24	[024]								
8	[008]							25	[025]								
9	[009]							26	[026]								
10	[010]							27	[027]								
11	[011]							28	[028]								
12	[012]							29	[029]								
13	[013]							30	[030]								
14	[014]							31	[031]								
15	[015]							32	[032]								
16	[016]							33	[033]								
17	[017]							34	[034]								

[074] First Keypad Options

Opt	Def.	ON	OFF
1	<input type="checkbox"/>	Future Use	✓ <input type="checkbox"/>
2	✓ <input type="checkbox"/>	[A] Key Enabled	<input type="checkbox"/> [A] Key Disabled
3	✓ <input type="checkbox"/>	[P] Key Enabled	<input type="checkbox"/> [P] Key Disabled
4	✓ <input type="checkbox"/>	Quick Arm Prompt ON	<input type="checkbox"/> Quick Arm Prompt OFF
5	<input type="checkbox"/>	Quick Exit Prompt ON	✓ <input type="checkbox"/> Quick Exit Prompt OFF
6	✓ <input type="checkbox"/>	Bypass Options Prompt ON	<input type="checkbox"/> Bypass Options Prompt OFF
7	✓ <input type="checkbox"/>	User Initiated Call-up Prompt ON	<input type="checkbox"/> User Initiated Call-up Prompt OFF
8	✓ <input type="checkbox"/>	Hold [P]anic Key Prompt ON	<input type="checkbox"/> Hold [P]anic Key Prompt OFF

[075] Second Keypad Options

Opt	Def.	ON	OFF
1	✓ <input type="checkbox"/>	Local Clock Display Enabled	<input type="checkbox"/> Local Clock Display Disabled
2	<input type="checkbox"/>	Local Clock Displays 24 Hr. Time	✓ <input type="checkbox"/> Local Clock Displays AM/PM
3	✓ <input type="checkbox"/>	Auto Alarm Scroll Enabled	<input type="checkbox"/> Auto Alarm Scroll Disabled
4	✓ <input type="checkbox"/>	Language Selection Accessible From Any Menu	<input type="checkbox"/> Language Selection Accessible From Installer Only
5	<input type="checkbox"/>	Power LED Enabled	✓ <input type="checkbox"/> Power LED Disabled
6	✓ <input type="checkbox"/>	Power LED indicates AC Present	<input type="checkbox"/> Power LED indicates AC Absent
7	✓ <input type="checkbox"/>	Alarms are Displayed while Armed	<input type="checkbox"/> Alarms are NOT Displayed while Armed
8	<input type="checkbox"/>	Auto Scroll Open Zones Enabled	✓ <input type="checkbox"/> Auto Scroll Open Zones Disabled

[076] Third Keypad Options

Opt	Def.	ON	OFF
1	✓ <input type="checkbox"/>	Chime Enabled for Zone Openings	<input type="checkbox"/> Chime Disabled for Zone Openings
2	✓ <input type="checkbox"/>	Chime Enabled for Zone Closings	<input type="checkbox"/> Chime Disabled for Zone Closings
3-8	<input type="checkbox"/>	Future Use	✓ <input type="checkbox"/>

[077] Programmed LCD Message

[078] Programmed LCD Message Duration

																																										Default 003 (Valid entries are 000-255, 000=Unlimited Message Display)
--	--	--	--	--	--	--	--	--	--	--	--	--	--	--	--	--	--	--	--	--	--	--	--	--	--	--	--	--	--	--	--	--	--	--	--	--	--	--	--	--	--	--

[201]-[234] Door Chime Options for Zones 1 - 34

Opt	Def.	ON	OFF
1	✓ <input type="checkbox"/>	6 Beeps	<input type="checkbox"/> Disabled
2	<input type="checkbox"/>	Bing Bing Sound	✓ <input type="checkbox"/> Disabled
3	<input type="checkbox"/>	Ding Dong Sound	✓ <input type="checkbox"/> Disabled
4	<input type="checkbox"/>	Alarm Tone	✓ <input type="checkbox"/> Disabled
5-8	<input type="checkbox"/>	Future Use	✓ <input type="checkbox"/>

[996] Reset Programmable Labels to Factory Defaults

Section 8: Programming Descriptions

The following is a brief description of the features and options available in the control panel.

Section [000] Keypad Function Key Programming

The five function keys can be reprogrammed with following functions. See Keypad Function Key Programming on page 16 for defaults

Option	Description	Option	Description
[00]	Null Key: Program non functioning keys with this option	[14]	Command Output #2: See [*][7][1] on page 13
[03]	Stay Arm: See Stay Arm on page 11	[16]	Quick Exit: See [*][0] on page 13
[04]	Away Arm: See Away Arm on page 11	[17]	Reactivate Stay/Away Zones: See [*][1] on page 11
[05]	No Entry Arm: See [*][9] on page 13	*[27]	Disarm: See Disarm on page 11
[06]	Chime On/Off: See [*][4] on page 12	*[29]	[A]ux Alarm: Same as [A] key
[08]	Bypass: See [*][1] on page 11	*[30]	[P]anic: Same as [P] key.
[13]	Command Output #1: See [*][7][1] on page 13	*Applies to Key Fobs only (See Section [804] Subsection [61]-[76])	

Section [001]-[002] Zone Definitions

Option	Description
[00]	Null Zone: Zone not used
[01]	Delay 1: When armed, provides entry delay when violated (follows Entry Delay 1)
[02]	Delay 2: When armed, provides entry delay when violated (follows Entry Delay 2)
[03]	Instant: When armed, instant alarm when violated
[04]	Interior: When armed, instant alarm if the zone is violated first, will follow entry delay if entry delay is active
[05]	Interior Stay/Away: Similar to 'Interior' except panel will auto-bypass the zone if armed in the Stay mode
[06]	Delay Stay/Away: Similar to 'Delay 1' except panel will auto-bypass the zone if armed in the Stay mode
[07]-[08]	Future Use
[09]	24-Hour Supervisory (Hardwired): Instant Alarm, silent at default.
[10]	24-Hour Supervisory Buzzer: Instant alarm, panel will activate keypad buzzer instead of bell output
[11]	24-Hour Burglary: Instant alarm when violated, audible alarm at default.
[12]	Future Use
[13]	24-Hour Gas: Instant alarm when violated, audible alarm at default.
[14]	24-Hour Heat: Instant alarm when violated, audible alarm at default (also known as high-temp).
[15]	24-Hour Medical: Instant alarm when violated, audible alarm at default.
[16]	24-Hour Panic: Instant alarm when violated, audible alarm at default.
[17]	24-Hour Emergency: Instant alarm when violated, audible alarm at default.
[18]	Future Use
[19]	24-Hour Water: Instant alarm when violated, audible alarm at default (also known as flood).
[20]	24-Hour Freeze: Instant alarm when violated, audible alarm at default (also known as low-temp).
[21]	Future Use
[22]	Momentary Keyswitch Arm: Arms or disarms the system when violated
[23]	Maintained Keyswitch Arm: Arms system when violated, disarms system when restored
[24]	For Future Use
[25]	Interior/Delay: Function as an Interior zone when armed in Away mode, and as a Delay zone when armed in the Stay mode
[26]	24-Hour Non-Alarm: Zone will NOT create an alarm. Can be used with chime to identify a specific event.
[27]-[31]	Future Use:
[32]	Instant Stay/Away: Similar to 'Instant' except panel will auto-bypass the zone if armed in the Stay mode
[33]-[35]	Future Use
[36]	24-Hour Non-Latching Tamper: Instant tamper condition when violated. Active in armed and disarmed state.

- [37] **Night Zone:** Functions like Interior Stay/Away (05) but will remain bypassed if the user presses [*][1] to re-activate Stay/Away zones when armed in the Stay mode
- [87] **Delayed 24-Hour Fire (Wireless):** Instant audible alarm when violated, communication delayed 30 seconds. If the alarm is acknowledged during the time delay (by pressing a key), the alarm will be silenced for 90 seconds and then the cycle is repeated. If the alarm is not acknowledged the alarm will latch and communicate after the 30 second delay.
- [88] **Standard 24-Hour Fire (Wireless):** Instant Alarm and Communication when violated.
- [89] **Auto-verified 24-Hour Fire (Wireless):** When the detector begins to sound, the system will monitor for a restoral transmission. If a restoral is not received within 40 seconds, the system will go into alarm and communicate with the central station. If a restoral is received within the 40 second period and a second detector of this zone type begins to sound within 80 seconds of the restoral, the system will also go into alarm and communicate with the central station.

Section [005] System Times

After entering Section [005], program the **Entry Delay 1**, **Entry Delay 2** and **Exit Delay** for the system. Entries are in seconds. Program the **Bell Cut-Off Time**. Valid entries are in minutes.

Section [006] Installer Code

The default Installer Code is [5555] or [555555] if 6-Digit Access Codes is enabled.

Section [007] Master Code

The default Master Code is [1234] or [123456] if 6-digit Access Codes is enabled.

Section [009] I/O Programming (Zones/PGMs)

The alarm system has two on-board terminals that are programmable as hardwired zones (Zones 33 and 34) or low current PGMs (PGM1 and PGM2). Enter the 2-digit zone definition or 2-digit PGM option required based on I/O type selected in Section [013] Opt [1] & [2].

PGM Output Options:

- | Option | Description |
|-----------|---|
| [00] | Null PGM: Not Used |
| [01] | Residential Fire and Burglary: Output will activate (steady for burglary, pulsing for fire) if an alarm occurs. |
| [02]-[04] | Future Use |
| [05] | System Armed Status: Output will activate when the system is armed |
| [06] | Ready to Arm: Output will activate when system is in the Ready state (Ready light ON) |
| [07] | Keypad Buzzer Follows Output: Activates when the keypad buzzer is activated for 24 hour Supervisory, Zone Alarms, Entry Delay, Audible Exit Delay, No Activity Arming Pre-alert, Audible Exit Fault and Door Chime. |
| [08] | Courtesy Pulse: Output will activate during entry/exit delay when the system is armed – will remain active for an additional 2 minutes after the entry or exit delay expires |
| [09] | System Trouble Output (with trouble options): Output will activate when any selected trouble condition is present. |
| [10] | System Event Output (with trouble options): Output will activate when any selected condition occurs. Output can be programmed to follow timer. |
| [11] | System Tamper: Output will activate when any tamper condition is present (i.e., zones) |
| [12] | TLM and Alarm: Output will activate if a telephone line trouble is present and then an alarm occurs |
| [13]-[16] | Future Use |
| [17] | Away Armed Status: Activates when the system is armed in Away mode |
| [18] | Stay Armed Status: Activates when system is armed in Stay mode |
| [19] | Command Output 1: Activates when a [*][7][1] command is entered on the keypad – Command can be programmed to require a valid access code and output can be programmed to activate for the time programmed in Section [170] or programmed to latch. |
| [20] | Command Output 2: Activates when a [*][7][2] command is entered on the keypad – Command can be programmed to require a valid access code and output can be programmed to activate for the time programmed in Section [170] or programmed to latch. |

Section [012] Keypad Lockout

The system can be programmed to 'lockout' the keypad if a series of incorrect user or installer codes are entered. When lockout is active, the system will emit a steady 2-second error tone when a key is pressed. Program the Number of Invalid Codes Before Lockout with the desired number. Valid entries are from [000] to [255]. Program data [000] to disable the feature. The keypad will remain locked out for the number of minutes programmed for the Lockout Duration. Valid entries are from [000] to [255].

Section [013] First System Options

Option	Description
[1]	ON: Hardwired Zone 33 enabled. OFF: PGM1 Output enabled. Program Zone Definition or PGM option in Section [009]
[2]	ON: Hardwired Zone 34 enabled. OFF: PGM2 Output enabled. Program Zone Definition or PGM option in Section [009]
[3]-[5]	Future Use
[6]	ON: Audible Exit Fault Enabled. If a delay zone is not secured correctly and not force-armed, at the end of the exit delay, the system will go into entry delay and turn ON the bell output. OFF: Audible Exit Fault Disabled. The keypad will sound the entry delay through the keypad.
[7]	ON: Event Buffer Follows Swinger Shutdown. The system will NOT log additional alarms for a zone that has reached the swinger shutdown threshold. OFF: Event Buffer Logs Past Shutdown. All zone alarms will be logged.
[8]	ON: Temporal Three Fire Signal Enabled. Temporal Three Fire Signal is used to annunciate fire alarms (½ second ON, ½ second OFF, ½ second ON, ½ second OFF, ½ second ON, 1 ½ seconds OFF). OFF: Standard Pulsed Fire Signal. The system will pulse the bell output (1 second ON, 1 second OFF).

Section [014] Second System Options

Option	Description
[1]	ON: Arm/Disarm Bell Squawk Enabled. The system squawks the bell output once when the system is armed, twice when disarmed and 3 times when disarming with alarms in memory. OFF: Arm/Disarm Bell Squawk Disabled. The bell output does not activate.
[2]	Future Use:
[3]	ON: RF Jam Logs after 5 Minutes. The system logs an RF Jam trouble condition if the condition is present for 5 minutes. OFF: RF Jam Logs after 20 Seconds. The system logs the trouble condition after 20 seconds.
[4]	ON: Aux Boost Enabled: When the system is in Power Save mode (AC Trouble) Aux+ output voltage is regulated 12VDC. OFF: Aux Boost Disabled: Aux+ output voltage is not regulated.
[5]	Future Use
[6]	ON: Audible Exit with Urgency. The system will beep the keypad once every second, and 3 times a second during the last 10 seconds, during exit delay when the system is armed with a user code or armed in the Away mode. OFF: Silent Exit Delay. The keypad will not beep.
[7]	Future Use:
[8]	ON: Fire Bell is Continuous. The bell output will not time out if a fire alarm occurs. The User must turn off the bell by entering a valid user code. OFF: Fire Bell follows Bell Cut-off. The bell output will time out normally.

Section [015] Third System Options

Option	Description
[1]	ON: [F] Key Enabled. The keypad [F] fire emergency key will be enabled. OFF: [F] Key Disabled. The keypad [F] fire emergency key will be disabled.
[2]	ON: [P] Key Audible (Bell/Beeps). The keypad [P] panic emergency will generate 3 ack beeps and the bell will activate for the duration of the BTO or until a code is entered. (The keypad will display “system in alarm”). OFF: [P] Key Silent. The keypad [P] emergency key generate a silent panic alarm. The bell will not sound and the keypad will not display “system in alarm”.
[3]	ON: Quick Exit Enabled. the Quick Exit feature will be enabled. OFF: Quick Exit Disabled. the Quick Exit feature will be disabled.
[4]	ON: Quick Arming Enabled. The Quick Arming [*][0] feature will be enabled. OFF: Quick Arming Disabled. Quick Arming [*][0] feature will be disabled.
	 <i>If this feature is disabled, a valid user code must be entered after the Stay or Away function buttons are pressed.</i>
[5]	ON: Code Required for Bypassing. A valid user code must be entered after pressing [*][1] to access the Bypass feature. OFF: No Code Required. A user code is not required for bypassing.
[6]	Future Use
[7]	ON: TLM Enabled. The system supervises the telephone line and displays a trouble if disconnected. OFF: TLM Disabled. The telephone line is not supervised.

- [8] **ON: System Tamper Enabled.** The panel will monitor the physical tamper switch, if the system is taken off the wall, or the front housing is removed, a System Tamper Alarm will be generated.
OFF: System Tamper Disabled: The panel will not monitor the physical tamper switch.

Section [016] Fourth System Options

Option Description

- [1] **ON: Cross Zoning Enabled.** The panel will use the Cross Zone Attribute for Burglary Verification.
OFF: Police Code Enabled. The panel will use the Police Code feature for Burglary Verification.
- [2] **ON: Exit Delay Restart Enabled.** A One-time Exit Delay Restart on Delay zone re-entry is enabled. If a Delay zone (Delay 1 or 2 only) is violated and restored once during the Exit Delay, it is considered an exit. If a delay zone is violated again it is considered a re-entry. This option will restart the exit delay. Further violations and restores of delay zones will not restart the exit delay.
OFF: Exit Delay Restart Enabled. One Time Exit Delay Restart on Delay zone re-entry is disabled. Delay zone violations and restores will not restart the exit delay. **(ON for SIA CP-01)**
-  *The exit delay can only be restarted once. This includes restarts from Away function keys. If the Exit Delay was silent, the additional Exit time should remain silent and will be double the programmed Exit Time.*
- [3] **ON: Blank Keypad when not Used.** The keypad blanks (no indicator lights) if a key is not pressed for 30 seconds.
OFF: Keypad Always Active. The keypad does not blank.
- [4] **ON: Code Required to Remove Keypad Blanking.** A valid user code must be entered to restore normal keypad operation.
OFF: No Code Required. Pressing any key will return the keypad to normal operation.
- [5] **ON: Keypad Backlighting Enabled.** Backlighting is enabled for LCD and Keys.
OFF: Keypad Backlighting Disabled. Backlighting is disabled for LCD and Keys.
- [6] **ON: Identified WLS Keys Not Required for Disarming.** The panel will accept the disarm keycode from an unidentified Wireless Key, allowing disarming with without an associated user code programmed.
OFF: Identified WLS Keys Required for Disarming. The panel will NOT accept the disarm keycode from an unidentified Wireless Key. An access code must be associated with a WLS KEY for proper operation.
- [7] **ON: Bypass Status Displayed While Armed.** the keypad displays the “Warning Bypass Active” prompt if zones are bypassed while the system is armed. **OFF: Bypass Status Not Displayed While Armed.** The “Warning Bypass Active” prompt is not displayed when the system is armed.
- [8] **ON: Daylight Saving Time Enabled.** Enables the Daylight Saving automatic clock adjustment feature.
OFF: Daylight Saving Time Enabled. The system does not automatically adjust the clock for Daylight Saving.

Section [023] Tenth System Options

Option Description

- [1] **ON: [F] Key Beeps Only.** The keypad [F] emergency key will only beep three times to acknowledge the button has been pressed. The system will not activate the siren. **OFF: [F] Key Beeps and Sounds Bell.** The system will activate the siren and beep the keypad.
- [2] **Future Use**
- [3] **ON: Test Transmission While Armed Only.** The system will only transmit the Test Transmission reporting code if the system is armed at the time the system is programmed to report the event. **OFF: Test Transmission while Armed/Disarmed.** The system will always report the Test Transmission reporting code at the programmed time.
- [4] **ON: Transmission Counter in Hours.** The system changes the Test Transmission Reporting Cycle Time from **Days** to **Hours**. **OFF: Transmission Counter in Days.** The Test Transmission Reporting Cycle Time is in **Days**.
- [5] **ON: Switching From Away to Stay Disabled.** The user can **NOT** switch from Away Arm mode to Stay Arm mode using the function keys. **OFF: Away to Stay Toggle Option Permitted.** The user can switch arming modes.
- [6] **ON: New Alarms will not Disconnect 2-way Audio.** The system will not disconnect a listen in/two-way session if an alarm occurs. **OFF: New Alarms Disconnects 2-way Audio.** The system will disconnect. New events are transmitted after the session ends.
-  *This option must be OFF for UL Listed Installations. Applies to SCW9047 only.*
- [7] **ON: Trouble Beeps are Silent.** The system does **NOT** activate the keypad buzzer for any trouble condition except fire.
OFF: Trouble Beeps Sound Every 10 Seconds. The system annunciates troubles via the keypad buzzer (2 beeps every 10 seconds).
- [8] **ON: Keyswitch Arms in Away Mode.** Keyswitch zones on the system will always arm the system in Away.
OFF: Keyswitch Arms in Stay or Away Mode. When a keyswitch zone is used to arm the system, the final armed mode will depend on whether the user trips a delay zone during exit delay. If the user trips a delay zone, then the system will arm in Away mode, if not, then the system will arm in Stay mode. This is similar to arming the system at the keypad with an access code. The exit delay will be audible.

Section [030] Zone Loop Response Options

This section is used to determine the Loop Response Time for hardwired zones 33 and 34.

ON: Fast Loop Response. The loop response time will be 36 mS.

OFF: Normal Loop Response. The loop response time will be 400 mS.

Section [101]-[134] Zone Attributes

These sections are used to customize the operation of the zones. There are 12 toggle options in each Section:

Option Description

- [1] **Bell Options - ON: Audible.** Alarms are audible (bell output). **OFF: Silent.** Alarms are silent.
- [2] **Bell Type - ON: Steady.** The bell output is steady (burglary). **OFF: Pulsed.** The alarm output pulses (fire).
- [3] **Chime Options - ON: Chime.** A zone violation or restore will activate Chime. **OFF:** Chime is not activated.
- [4] **Bypass Options - ON: Bypass.** The user can manually bypass the zone using the **[*][1]** command. **OFF:** the zone cannot be manually bypassed.
- [5] **Force Arming Options - ON: Force Arm.** The system can be armed even if the zone is violated (the zone will not affect the Ready status). **OFF:** the zone must be secure before arming.
- [6] **Swinger Shutdown - ON: Swing.** The system shuts down alarm reporting after the programmed number of alarms have occurred. **OFF:** the panel will always report the event if an alarm occurs.
- [7] **Transmission Delay Options - ON: TX Delay.** The system delays reporting the event for the time programmed for the Transmission Delay time. **OFF:** the panel immediately transmits the reporting event when an alarm is detected.
- [8] **Cross Zone Option - ON: Cross Zone.** The zone has the Cross Zone feature enabled. **OFF:** the zone functions normally.
- [9] **2-way Audio Options - ON: 2-way Audio.** The zone will initiate a 2-Way Audio Verification session with the Central Station. **OFF:** This zone will not initiate a 2-Way Audio session.

[10]-[13] Future Use

- [14] **NC Loops - ON:** This zone follows the Normally Closed (NC) loop configuration. **OFF:** Checks end of line configuration for SEOL
- [15] **SEOL - ON:** This zone follows the SEOL zone configuration. **OFF:** Checks end of line configuration for DEOL.
- [16] **DEOL - ON:** This zone follows the DEOL zone configuration. **OFF:** If options 14, 15, and 16 are off, then NC loops will be followed



If more than one option (14, 15, and 16) is selected, the lowest option number will take precedence (i.e., If option 14 and 15 are both selected, option 14 will be enabled).

When Zone Types (Section [001] to [002]) are programmed, the system will change the Zone Attributes to those found in the chart included in the Programming Worksheets. The Zone Attributes will default if a new Zone Type is programmed for a specific zone.

After programming the Zone Types, enter Section [101] to [134] and ensure that all options are programmed correctly.

Ready light **ON:** Program attributes [1-8]

Ready light and Armed light **ON:** Program attribute [9-16] (press [1] for option 9, press 6 for option 14 etc.)

Press [9] to switch between attributes [1-8] and attributes [9-16].

Section [168] Daylight Saving Time (Move Clock Ahead)

Program the 3-digit Month (Data [001] to [012] represents January to December), the 3-digit Week (Data [000] represents day of the month, Data [001] to [005] represents weeks 1 to 5 of the month), the 3-digit Day (Data [001] to [031] represents day of the month if [000] was programmed in the 3-digit Week entry. If [001] to [005] was programmed then Data [000] to [006] represents Sunday to Saturday), the 3-digit Hr. to initiate the change (Data [000] or [023] represents the hour to make the change) and the Increment (Data [001] or [002] represents the number of hours to adjust).

Section [169] Standard Time (Set Clock Back)

Program the 3-digit Month (Data [001] to [012] represents January to December), the 3-digit Week (Data [000] represents day of the month, Data [001] to [005] represents weeks 1 to 5 of the month), the 3-digit Day (Data [001] to [031] represents day of the month if [000] was programmed in the 3-digit Week entry. If [001] to [005] was programmed then Data [000] to [006] represents Sunday to Saturday), the 3-digit Hr. to initiate the change (Data [000] or [023] represents the hour to make the change) and the Increment (Data [001] or [002] represents the number of hours to adjust).



If Daylight Saving Time occurs at Midnight program the time 2:00AM.

Section [170] PGM Output Timer

Program the time, in seconds, PGM outputs programmed to follow the PGM Output Timer will activate for. Valid entries are [001] to [255].

Section [176] Cross Zone/Police Code Timer

Program the time, in seconds (Cross Zone) or minutes (Police Code), that the panel will use to determine if a Cross Zone or Police Code event has occurred. If data [000] is programmed when using the Police Code feature, the panel will generate a Police Code event if any two zones go into alarm during any armed-to-armed period. Valid entries are [001] to [255].

Section [190] No Activity Arming Pre-Alert Duration

Program the time, in minutes, for the No Activity Arming Pre-Alert Duration. The keypad will provide a steady tone warning the user that the system will arm. The user can either violate a zone or press any key to abort the arming sequence. Valid entries are [000] to [255].

Section [191] No Activity Arm Timer

Program the time, in minutes, for the No Activity Arm Timer. If Delay Zones are restored and no zone activity is detected for the time programmed, the system will start the auto arm sequence. Valid entries are [000] to [255].

Section [202]-[206] Zone Assignments

Activates the selected zones. Zones 1-8 are ON by default. Zones 9 - 34 are OFF by default. If a zone is enabled, it will be supervised and will operate according to the zone type programmed. If a zone is not assigned, it will not be supervised and all activity on the zone will be ignored by the panel.



If a zone assignment is set, but no serial number is enrolled (zones 1 to 32), or the terminals are set as PGM outputs instead of zone inputs (zones 33 and 34), then these zones will appear in the bypass list.

Section [301]-[303] Communication Telephone Numbers

Program the phone numbers as required. Phone Number 3 is dedicated as a back-up to Phone Number 1. HEX digits can be included for special applications:

HEX [A]	Not used
HEX [B]	Simulates a [*] key press
HEX [C]	Simulates a [#] key press
HEX [D]	Additional dial tone search
HEX [E]	2-second pause
HEX [F]	End of phone number marker

Section [304] Call Waiting Cancel String

Program the digits required to disable call waiting. If enabled, the system will dial the programmed string on the first dialing attempt. Program unused digits with data [F]. This section is activated in Section [382] Opt [4].

Section [310] System Account Number

Program the System Account Number. Only the SIA format supports 6-digit account numbers. If a 4-digit account number is required, program the last two digits as data [FF]. For formats other than SIA, program a HEX [A] for any digit [0] in the account number being used.

Section [320]-[348] Reporting Codes

Program the reporting code for all events to be transmitted. For description of when each reporting event will be transmitted, refer to Appendix A – Reporting Codes. The panel also supports Automatic SIA and Automatic Contact ID reporting. Program data [00] to disable the reporting of an event. If any other data is programmed (Data [01] to [FF]) the panel will automatically generate the correct reporting event when transmitting to the central station. For all formats excluding Automatic SIA and Automatic Contact ID, the panel will not attempt to report an event if data [00] or data [FF] is programmed for the reporting code.

Section [350] Communicator Format

Program the 2-digit number for the desired Communicator Format for the First Phone Number and Second Phone Number. When dialing the Third Phone Number, the system will use the Communicator Format programmed for Phone Number 1. Valid entries are [01] to [06]. Refer to the Programming Worksheet for a list of the available Communicator Formats. Refer Appendix B: Communicator Format Options on page 52 for details

Section [351]-[376] Communicator Call Direction Options

Reporting events are categorized into 5 groups; Alarm/Restoral, Opening/Closing, Tamper Alarm/Restoral, System Maintenance and Test Transmissions. Program which Phone Number the control panel will use to transmit reporting events by turning the option **ON** in the correct Section. Phone Number 1 and/or Phone Number 2 can be used.

Section [377] Communicator Variables

Program a 3-digit number for each program entry:

Swinger Shutdown (Alarms): Maximum number of alarm/restoral transmissions per zone. Valid entries: [000] to [014]. Program data [000] to disable shutdown.

Swinger Shutdown (Tamper): Maximum number of tamper alarm/restoral transmissions per zone. Valid entries: [000] to [014]. Program data [000] to disable shutdown.

Swinger Shutdown (Maintenance): Maximum number of trouble alarm/restoral transmissions per trouble condition. Valid entries: [000] to [014]. Program data [000] to disable shutdown.

Communicator (Transmission) Delay: Time, in seconds, panel will delay reporting an alarm event. Valid entries: [000] to [255].

AC Failure Communication Delay: Time in minutes or hours, panel will delay reporting an AC trouble event or restoral. Valid entries: [000] to [255].

TLM Trouble Delay: Time, in 3 second checks, before the system will consider the phone line disconnected. Valid entries: [003] to [255] (e.g., 3 x10 seconds = 30 seconds).

 *TLM Restoral follows the same delay.*

Test Transmission Cycle (Land Line): Number of days or hours between test transmission reporting events. Valid entries: [001] to [255].

Wireless Zone Low Battery Delay: Number of days the system will delay reporting a wireless low battery to the central station. Valid entries: [000] to [255]. Program data [000] for no delay.

Delinquency Transmission Delay: Number of hours (Activity Delinquency) or days (Arming Delinquency) the panel will delay before transmitting the event to the central station. Valid entries: [001] to [255].

Communication Cancelled Window: Time, in minutes, after an alarm has occurred that the system will report a Communication Cancel reporting event if the system is disarmed. The keypad will display “Communication Cancelled” to indicate that the communication cancelled reporting event has been successfully sent to the monitoring station. Valid entries: [005] to [255].

Section [378] Test Transmission Time

Program the time the system will report a Test Transmission reporting event. Program 4 digits – [HHMM] using military standard. For a test transmission at 11:00 pm, program data [2300]. Valid entries are [0000] to [2359], [9999] to disable.

Section [380] First Communicator Options

Option	Description
[1]	ON: Communications Enabled. The system communicator is enabled. OFF: Communications Disabled. The communicator is disabled.
[2]	ON: Restorals on Bell Time-out. The system transmits alarm restorals if the zone is restored and the bell has timed out. OFF: Restorals Follow Zones. The system transmits alarm restorals immediately when the zone is restored.
[3]	ON: Pulse Dialing. The panel uses rotary (pulse) dialing. OFF: DTMF Dialing. The panel uses touchtone (DTMF) dialing
[4]-[5]	Future Use
[6]	ON: Alternate Dial (1st & 3rd). The system alternates between the First Phone Number and Third Phone Number when attempting to report an event. OFF: Call 1st No. Backup to 3rd. The panel will dial the First Phone Number for the programmed number of attempts, then switch to the Third Phone Number.
[7]	For Future Use
[8]	ON: Delinquency Follows Zone Activity (Hours). The Delinquency feature follows zone activity. OFF: Delinquency Follows Arming (Days). The Delinquency feature follows arming.

Section [381] Second Communicator Options

Option	Description
[1]	ON: Opening After Alarm Keypad Ringback Enabled. When the Opening After Alarm reporting code is successfully transmitted to a programmed telephone number, the keypad will sound a series of 8 beeps to confirm to the end user that the Opening After Alarm Code was sent and received. This Ringback will occur for each Opening After Alarm code successfully reported. OFF: Opening After Alarm Keypad Ringback Disabled. Disabled
[2]	Future Use
[3]	ON: SIA Uses Programmed Reporting Codes. The system uses programmed reporting codes when transmitting using the SIA format. OFF: SIA Uses Automatic Reporting Codes. The system automatically generates all reporting codes transmitted.
[4]	ON: Closing Confirmation Enabled. The system beeps the keypad 8 times after successfully transmitting a Closing reporting event. OFF: Closing Confirmation Disabled. The keypad does not beep.
[5]	ON: Talk/Listen on Phone #1/3 Enabled. If Talk/Listen is requested for an event, the panel will request the session on the next communication on Phone Number 1/3 (via L-Block) to the central station. OFF: Talk/Listen on Phone #1/3 Disabled. The panel will not request a Talk/Listen session.
SCW9047 Only	
[6]	ON: Talk/Listen on Phone #2 Enabled. If Talk/Listen is requested for an event, the panel will request the session on the next communication on Phone Number 2 (via L-Block) to the central station. OFF: Talk/Listen on Phone #2 Disabled. The panel will not request a Talk/Listen session.
SCW9047 Only	
[7]	ON: Contact ID Uses Programmed Reporting Codes. The system uses Contact ID format programmed reporting codes when transmitting reporting codes. OFF: Contact ID Uses Automatic Reporting Codes. The system automatically generates all reporting codes transmitted.
[8]	Future Use

Section [382] Third Communicator Options

Option	Description
[1]	ON: Partial Closing Identifier is '5'. The system will use the digit [5] as the first digit of the Partial Closing reporting code when transmitting Contact ID reporting codes. OFF: Partial Closing Identifier is '4'. The system will use the digit [4] as the first digit of the Partial Closing reporting code when transmitting Contact ID reporting codes.
[2]	ON: Alarm Communications Enabled During Walk Test. The system will transmit all alarms during Walk Test. OFF: Alarm Communications Disabled During Walk Test. The system will not report alarm events during Walk Test.
[3]	ON: Communications Cancelled Message Enabled. The keypad will display the message ' Communications Cancelled ' upon successful transmission of the Communication Cancelled reporting event. OFF: Communications Cancelled Message Disabled. The keypad will not display these messages. (ON for SIA CP-01)
[4]	ON: Call Waiting Cancel Enabled. The system dials the Call Waiting Cancel string on the first attempt to dial the central station. OFF: Call Waiting Cancel Disabled. The system does not dial the Call Waiting Cancel string.
[5]-[6]	Future Use
[7]	ON: Residential Dialing Attempts are 1. Number of Dialing Attempts is one when using Residential Dial communication format. OFF: Residential Dialing Attempts are 5. Residential Dial Follows Dialling Attempt counter.
[8]	Future Use

Section [401] First Downloading Options

Option	Description
[1]	ON: Answering Machine Double Call Enabled. The system answers incoming calls for downloading (either Programmed Number of Rings or Double Call). OFF: Answering Machine Double Call Disabled. The system does not answer incoming calls for double call attempts, but will still answer on Programmed Number of Rings.  <i>These settings do not affect the 6 hour DLS downloading window on power up.</i>
[2]	ON: User Can Enable DLS Window. The user can enable downloading for the DLS downloading window (double call only) using the [*][6] command. OFF: User Can NOT Enable DLS Window. The user can not enable the DLS downloading window using the [*][6] command.
[3]	ON: Call Back Enabled. The system will hang up after a successful DLS connection and call the computer back using the DLS Phone Number (Section [402]). OFF: Call Back Disabled. The system stays connected to the computer.

- [4] **ON: User Initiated Call-up Enabled.** The user can initiate a downloading session using the [*][6] command. **OFF: User Initiated Call-up Disabled.** The user cannot initiate a downloading session.
- [5] **Future Use**
- [6] **ON: 300 Baud Panel Call-Up.** When the user initiates a DLS connection, the panel will connect and send the initial header at 300 baud. **OFF: 110 Baud Panel Call-Up.** When the user initiates a DLS connection, the panel will connect and send the initial header at 110 baud. The panel will then switch to 300 baud in order to receive the response from the DLS computer.
- [7]-[8] **Future Use**

Section [402] Downloading Computer Phone Number

The Downloading Computer Telephone Number is used for Call Back and User Initiated DLS functions. Program the phone number as required. HEX digits can be included for special applications:

HEX [A]	Not used
HEX [B]	Simulates a [*] key press
HEX [C]	Simulates a [#] key press
HEX [D]	Additional dial tone search
HEX [E]	2-second pause
HEX [F]	End of phone number marker

Section [403] Downloading Access Code

Program the 6-digit Downloading Access Code. Upon connection, the system will only connect to the downloading computer if the Downloading Access Code programmed matches the Downloading Access Code programmed in the computer file.

Section [404] Panel Identification Code

Program the 6-digit Panel Identification Code. This code is used by the downloading computer to verify the correct account is calling back (Call Back feature) or to identify which customer account file should be used (User Initiated DLS features).

Section [406] Number of Rings to Answer On

The value in this section determine how many rings that the panel will automatically pick up on in order to establish a DLS connection. Default value is 000 rings. Valid entries are [000]-[009].

 *If Section [401] Option 1 and Section [406] are both enabled, either one will work depending on how the installer calls the premises.*

Section [499] Initiate PC-Link Downloading

Enter the following command to initiate downloading via PC-Link – Section [499] [Installer Code] [499]. Plugging in the PC-Link connector will automatically initiate the connection if DLS is initiated before connecting the PC-Link Header. The session will NOT be automatically initiated if the system is in installer mode.

Section [501]-[502] PGM 1 & 2 Output Attributes

Allows the user to customize PGM1 and PGM2 Attributes. The following attributes can be enabled or disabled for each PGM output. When a PGM option is changed, the corresponding PGM's attributes are defaulted.

The following attributes are available for PGM Output Types [01], [05]-[08] and [17]-[20].

Option Description

[1]-[2] **Not Used**

- [3] **ON: True Output.** Output will activate (switch to ground) when the event occurs.
OFF: Inverted Output. Output will de-activate (switch to open) when the event occurs.

 *This attribute is also available for PGM Output Types [11] and [12].*

- [4] **ON: Output Pulsed.** The output will activate for the duration programmed in the PGM Output Timer, Section [170].
OFF: Output On/Off. The output will toggle between on and off when the corresponding [*][7] command is entered.

 *This attribute is available only for PGM Output Types [11] and [19]-[20].*

- [5] **ON: Access Code Required for Activation. OFF: No Access Code Required for Activation.**

 *This attribute is available only for PGM Output Types [19]-[20].*

The following attributes are available for PGM Output Type [09]

- [1] **ON:** PGM output activates if a Service Required trouble condition is present.
- [2] **ON:** PGM output activates if an AC trouble condition is present.
- [3] **ON:** PGM output activates if a Telephone Line trouble condition is present.
- [4] **ON:** PGM output activates if a Failure to Communicate trouble condition is present.
- [5] **ON:** PGM output activates if a Zone Fault condition is present.
- [6] **ON:** PGM output activates if a Zone Tamper condition is present.
- [7] **ON:** PGM output will activates if a Wireless Low Battery trouble condition is present.
- [8] **ON:** PGM output will activates if a Loss of Clock trouble condition is present.

The following attributes are available for PGM Output Type [10]

- [1] **ON:** PGM output activates if a Burglary Alarm occurs.
- [2] **ON:** PGM output activates if a Fire Alarm occurs.
- [3] **ON:** PGM output activates if a Panic Alarm occurs.
- [4] **ON:** PGM output activates if a Medical Alarm occurs.
- [5] **ON:** PGM output activates if a Supervisory Alarm occurs.
- [6] **ON:** PGM output activates if a Priority Alarm occurs.
- [7] **ON:** PGM output will activates if a 24-Hour Duress Alarm occurs.
- [8] **ON:** the PGM output activates for the time programmed for the PGM Output Timer.
OFF: the PGM output will latch until a valid user code is entered.

Section [600] 2-way Audio Control Options (applies to SCW9047 only)

Option Description

- [1] **ON: Tamper Enabled.** The Talk/Listen-in session initiates for tamper conditions
OFF: Tamper Disabled. 2-way Audio is disabled for tamper conditions
- [2] **ON: Openings and Closings Enabled.** The Talk/Listen-in session initiates for Openings & Closings events
OFF: Openings and Closings Disabled. 2-way Audio is disable for Openings & Closings events
- [3] **ON: [A] Key Alarm Enabled.** The Talk/Listen-in session initiates for [A] Key Alarm
OFF: [A] Key Alarm Disabled. 2-way Audio is disabled for [A] Key Alarm
- [4] **ON: [P] Key Alarm Enabled.** The Listen-in session initiates for [P] Key Alarm if the [P] Key is programmed to be Silent. If the [P] Key is programmed to be audible, the 2-way audio session will be Talk/Listen-in.
OFF: [P] Key Alarm Disabled. 2-Way Audio is disabled for [P] Key Alarm
- [5] **ON: Duress Alarm Enabled (Listen).** The Listen-in session initiates for Duress Alarm
OFF: Duress Alarm Disabled. 2-Way Audio is disabled for Duress Alarm
- [6] **ON: Opening after Alarm Enabled.** The Talk/Listen-in session initiates for Opening After Alarm
OFF: Opening after Alarm Disabled. 2-Way Audio is disabled for Opening After Alarm
- [7] **ON: Bell Active during 2-way Audio Verification.** The sounder will remain active during a 2-way Audio session when an audible alarm is present **OFF: Bell Silent during 2-way Audio Verification.** The sounder will be silent when a 2-Way Audio session begins when and audible alarm is present, allowing the user to hear the operator. The sounder will resume operation for the timeout duration if the panel has not been disarmed at the end of the 2-way session

 *This option must be ON for UL Listed Installations.*

- [8] **Future Use**

Section [700] Automatic Clock Adjust

Program the number of seconds for the last minute of the day. This can be used to make minor corrections to the clock if the AC frequency is not reliable. Valid entries are [01] to [99].

Section [701] First International Options

Option	Description
[1]	ON: 50 Hz AC. Configures the system for 50Hz AC. OFF: 60 Hz AC. Configures the system for 60Hz AC
[2]	ON: Time Base Internal Crystal. The system uses the internal crystal for the internal panel clock. OFF: Time Base AC-Line. The system uses the AC frequency for the internal panel clock.
[3]	ON: AC/DC Arming Inhibit with Battery Check Enabled. The system will inhibit arming if a Low Battery or AC trouble condition is present. OFF: Arming not Inhibited. Arming will not be inhibited.
[4]	ON: System Tamper Require Installer Reset. All Tamper troubles will latch and arming will be inhibited. Enter Installer Programming to clear the trouble condition and return to normal operation. OFF: System Tamper Do Not Require Installer Reset. Tamper troubles will not latch and will not inhibit arming. Manual bypassing of a zone will not bypass the tamper or fault states (DEOL).
[5]	ON: 6-digit Access Codes. All access codes are 6 digits long. OFF: 4-digit Access Codes. All access codes are 4 digits long.
[6]	ON: Busy Tone Detection Enabled. The system will hang up if a busy tone is detected. This attempt is not counted towards the maximum dialing attempts. OFF: Busy Tone Detection Disabled. The system will not detect busy tones.
[7]-[8]	Future Use

Section [702] Second International Options

Option	Description
[1]	ON: Pulse Dialing Make/Break ratio is 33/67. The communicator uses 33/67 make/break ratio when pulse dialing. OFF: Pulse Dialing Make/Break ratio is 40/60. The system uses 40/60 make/break ratio.
[2]	ON: Force Dialing Enabled. The system dials regardless of the presence of dial tone after the first attempt. OFF: Force Dialing Disabled. The system dials only if dial tone is detected.
[3]	Future Use
[4]	ON: 1600Hz Handshake. 1600Hz Handshake used. OFF: Standard Handshake. Standard Handshake is used.
[5]	ON: ID Tone Enabled. The system generates a tone for 500mS every 2 seconds indicating digital equipment is making the call vs. a voice call. OFF: ID Tone Disabled. The system does not generate a tone.
[6]	ON: 2100 Hz. ID Tone. The tone generated (2100Hz.) indicates that digital equipment is making the call. OFF: 1300 Hz. ID Tone. The tone is 1300Hz.
[7]-[8]	Future Use

Section [703] Delay Between Dialing Attempts

Program the time the system will wait between dialing attempts to transmit a reporting event to the central station. Valid entries are [001] to [255].

Section [804] Wireless Programming

The following programming sections are used to program wireless devices. Enter the associated 6-digit Electronic Serial Number (ESN).

Sub Section [01]-[32] Wireless Zone Programming

These sections are used to enter the wireless zone serial numbers. This is a 6 digit hexadecimal entry. For toggling entries between decimal and hexadecimal values press [*]. The first digit of the serial number is used to identify the type of device:

- 2 = Door/Window Contact
- 3 = PIR or Glass Break Detector
- 4 = Smoke Detector
- 5 = Panic Pendant

Sub Section [41]-[56] Wireless Key Programming

These sections are used to enter the wireless key serial numbers. This is a 6 digit hexadecimal entry. For toggling entries between decimal and hexadecimal values press [*]. The first digit of the wireless keys can be either '6' or '9'.

The following 5 digits are the same as the device serial numbers.

Sub Section [61]-[76] Wireless Key Function Key Programming

Up to 4 functions can be programmed uniquely for each wireless key. Refer to Function Key Options on page 16 for a list of functions that can be programmed in the wireless keys.

Sub Section [81] Wireless Supervisory Window (Entry Value x 15 minutes) (4 - 96 = 1 - 24Hr Window)

This entry is in minutes and when multiplied by 15, determines the length of the supervisory window, valid entries are between 04 to 96 for 1 to 24 hours. The default for the North American market is 96 (24 hours), for the European market is 10 (2.5 hours).

Sub Section [82]-[85] Wireless Zone Supervision (Zones 1 - 32)

Programming these sections determines whether or not the zone transmitter will be supervised.

 **Panic Pendants do not send Supervisory signals and cannot be supervised.**

Sub Section [90] General Wireless Options (Zones 1 - 32)

Option	Description
--------	-------------

[1]-[6]	Future Use
---------	-------------------

[7]	ON: RF Jam Disabled. RF Jam is disabled. OFF: RF Jam Enabled. RF Jam is enabled.
-----	--

[8]	ON: Global Placement Test All placements (zones) tested. OFF: Individual Module Placement Test. Installer must enter zone number for placement test.
-----	--

Section [898]: Wireless Device Enrollment - See Section 2 of this manual.

Section [899]: Template Programming - See Section 3 of this manual.

Section [900]: Panel Version Displayed

Section [900]: Display Panel Version. The system will display the version of the control panel (for example, [0100] indicates panel version 1.00).

Section [904]: Wireless Module Placement Test

Enter Section [904] followed by the 2-digit number of the wireless zone to test. When a wireless signal is received from the selected transmitter, the system will indicate the location as **Good** or **Bad** as follows:

Good: One bell squawk, keypad displays 'GOOD'

Bad: Three bell squawks, keypad displays 'BAD'

Press [#] to exit when testing is complete. Enter the 2-digit zone number for the next wireless device to test or press [#] to return to standard programming.

Section [990] Installer Lockout Enable

Enter Section [990][Installer Code][990] to enable the Installer Lockout feature. A hardware default cannot be performed when the Installer Lockout feature is **ON**. In addition, the system will chatter the line seizure relay 10 times if the panel is powered up to indicate the feature is **ON**.

Section [991] Installer Lockout Disable

Enter Section [991][Installer Code][991] to turn the Installer Lockout feature **OFF**.

Section [996] Restore Wireless Device Default Programming

Enter Section [996][Installer Code][996] to return wireless programming to factory defaults.

Section [998] Restore Control Panel Default Programming

Enter Section [998][Installer Code][998] to return control panel programming to factory defaults.

 **Wireless device programming and keypad programming are not defaulted**
To default Labels see Section [996] Label Reset in Keypad Programming
To default Wireless Devices see Section [996] above

Section [999] Restore System Default Programming

Enter Section [999][Installer Code][999] to return system programming to factory defaults.

 **Except for Labels, All programming including wireless device programming and keypad programming will be returned to factory defaults.** *To default Labels see Section [996] Label Reset in Keypad Programming*

Hardware Reset (Default) Main Control Panel

Perform the following to default the main control panel:

- Power down the system completely.
- Connect a short between I/O 1 and I/O 2 on the control panel (remove all other wires from these terminals).
- Power up the control panel (AC power only) for 10 full seconds.
- Power down the control panel, remove short between I/O 1 and I/O 2.
- Power up the control panel.

Keypad Programming

To access Keypad Programming enter **[*][8][Installer's Code][*]**.

To return to System Programming press **[*]**.

System Labels

There are 39 programmable system labels which are programmable through the Keypad or Downloading. Once a label programming section has been entered, use the [

[<] = Display Left (Previous)	[6] = P Q R 6
[>] = Display Right (Next)	[7] = S T U 7
[1] = A B C 1	[8] = V W X 8
[2] = D E F 2	[9] = Y Z 9 0
[3] = G H I 3	[0] = SPACE
[4] = J K L 4	[*] = SELECT
[5] = M N O 5	[#] = ESCAPE

For example, if you press the [4] key once, the letter "J" will appear above the cursor on the display. Press the [4] key again, the next letter "K" will appear, and so on. If a different number is pressed, e.g. the [6] key, the cursor will automatically move to the right one space, i.e. the letter "P". To erase a character, use the [

SAVE	Saves the new label.
CHANGE CASE	Toggles the letter entry between upper case letters (A,B,C...) and lower case letters (a,b,c...).
ASCII ENTRY	For entering uncommon characters. There are 255 characters. Use the [<lt;] 000-255.<br="" 3="" [>]="" a="" characters="" digit="" enter="" from="" keys="" number="" or="" scroll="" the="" through="" to=""></lt;]> Press the [*] key to enter the character into the label.
CLEAR TO END	Clears the display from the character where the cursor was located to the end of the display.
CLEAR DISPLAY	Clears the entire label field.

Section [001]-[034] Zone Labels

Enter a 28 character zone label for up to 32 wireless zones and 2 hardwired zones (33 & 34).

Default Value = 'ZONE----XX' where XX equals the zone number.

Section [065] Fire Alarm Labels

Enter a 28 character Fire Alarm label. Default Value = 'FIRE-ZONE'.

Section [066] Fail to Arm Event Message

Enter a 32 character Fail to Arm Event Message. Default Value = 'SYSTEM HAS -----', 'FAILED-TO-ARM---'.

Section [067] Alarm when Armed Event Message

Enter a 32 character Alarm when Armed Event Message. Default Value = 'ALARM-OCCURRED--', 'WHILE-ARMED----'.

Section [068]-[069] Command Output Label

Enter a 28 character Command Output Label label for each command Output (2 MAX).

Default Value = 'COMMAND-O/P-X-' where X equals the Command Output number.

Section [074] First Keypad Options

Option	Description
[1]	Future Use
[2]	ON: [A] Key Enabled. When the [A] key is pressed and held, the keypad will generate a [A]ux key alarm. The display will prompt the user to hold the key. OFF: [A] Key Disabled. Prevents the keypad from requesting a [A]ux key alarm.
[3]	ON: [P] Key Enabled. When the [P] key is pressed and held, the keypad will generate a [P]anic key alarm. The display will prompt the user to hold the key, depending on the setting of Option 8 (in this section). OFF: [P] Key Disabled. Prevents the keypad from requesting a [P]anic key alarm.
[4]	ON: Quick Arm Prompt is enabled. When in the Disarmed Star menu, the <i>Quick Arm</i> prompt will be displayed. OFF: Quick Arm Prompt is disabled. The <i>Quick Arm</i> prompt is disabled.
[5]	ON: Quick Exit Prompt is enabled. When in the Armed Star menu, the <i>Quick Exit</i> prompt will be displayed. OFF: Quick Exit Prompt is disabled. The <i>Quick Exit</i> prompt is disabled.
[6]	ON: Bypass Options Prompt is enabled. In the [*1] Bypass menu, the <i>Bypass Options</i> prompt will be displayed. This is a local function prompt. When selected, the keypad will display the Bypass Options menu. OFF: Bypass Options Prompt and menu is disabled. Prompt and menu is disabled.
[7]	ON: User Initiated Call-Up Prompt is enabled. In the [*6] User Functions menu, the User Initiated Call-up prompt will be Displayed. When this prompt is selected, the keypad will send a [6] key. OFF: User Initiated Call-Up Prompt is disabled. The prompt is not displayed.
[8]	ON: Hold [P] Key Prompt is enabled. When holding the [P] key, the display will prompt the user to hold the [P] key to generate a Panic alarm. This is a local prompt. OFF: Hold [P] Key Prompt is disabled. When holding the [P] key, the user will receive no feedback that the key has been pressed. The display and backlighting will not change.

Section [075] Second Keypad Options

Option	Description
[1]	ON: Local Clock Enabled: When the keypad is not being used, the keypad will return to displaying the Time and Date until another key is pressed. OFF: Local Clock Disabled
[2]	ON: Local Clock Displays 24 Hour Time. When this feature is enabled, the time is displayed in 24 hour military format. OFF: Local Clock Displays AM/PM Time. When this feature is enabled, the time is displayed in 12 hour format (AM/PM).  <i>This option does not affect the time programming menu, which is always in 24-hour time format.</i>
[3]	ON: Auto Alarm Scroll Enabled. When the bell is active or when there is an alarm in memory while armed, the keypad will scroll automatically and display all alarms. OFF: Auto Alarm Scroll Disabled. The keypad will not scroll automatically and display all alarms.
[4]	ON: Language Selection Accessible from Any Menu. Pressing <> and holding for 2 seconds displays the language selection menu. OFF: Language Selection Accessible from Installer's Menu Only. Pressing <> and holding for 2 seconds generates an error tone.
[5]	ON: Power LED is enabled. The LED functionality is defined by Option 6. OFF: Power LED is disabled. Option 6 has no effect.
[6]	ON: Power LED Indicates AC Present. If AC is present then the LED will be ON to indicate AC power is present. If AC is absent then the LED will be OFF indicating that the AC power is lost. OFF: Power LED Indicates AC Absent. If AC is present then the LED will be OFF to indicate that the AC is present and there is no trouble. If the AC is absent then the LED will be ON steady to indicate that there is a problem with the AC power.
[7]	ON: Alarms are Displayed while Armed. If any alarms occur while armed, the keypad will display the alarms by identifying the zones. OFF: Alarms are Not Displayed while Armed. If any alarms occur while armed, the keypad will not show any indication that an alarm occurred on the system. When the system is disarmed, the keypad will still enter Alarm Memory to indicate which zones went into alarm during the alarm period.
[8]	ON: Auto Scroll of Open Zones is enabled. When a zone is open, the keypad will scroll automatically and display all open zones. Open zones also override the local clock display. OFF: Auto Scroll of Open Zones is disabled. Open zones are not displayed

Section [076] Third Keypad Options

Option Description

- [1] **ON: Chime Enabled for Zone Openings.** When the zone is open and the chime feature is enabled ([*][4] Door Chime), the keypad will chime the selected chime tone for the zone. **OFF: Chime Disabled for Zone Openings.** The keypad will not chime for zone openings
- [2] **ON: Chime Enabled for Zone Closings.** When the zone is closed and the chime feature is enabled ([*][4] Door Chime), the keypad will chime the selected chime tone for the zone. **OFF: Chime Disabled for Zone Closing.** The keypad will not chime for zone closings
- [3-8] **Future Use**

Section [077] Programmed LCD Message

Enter a 32 character message. If there is any thing other than blanks programmed into this section, the keypad will time out to this message instead of the Time and Date display. Any option or feature that overrides the clock display will also override the LCD message. An override by the system will not be counted against the Message Duration programmed in Section [078]. This message can be programmed in Installers Programming or using DLS.

Section [078] Programmed LCD Message Duration

Enter a 3 digit number. Valid Entries are 001 to 255 seconds. 000 = Unlimited Duration.

This section is used to program the number of times an LCD message must be cleared from the LCD displays (by pressing any key) before it will no longer be displayed. When programmed on the system, the LCD keypad will display the message when not in use. Programming 000 in this section will result in the message never clearing. This could be used as a greeting (residential) or a company message (commercial). This overrides the settings of Clock Display options in Section [075].

Section [201]-[234] Door Chime Options for Zones 1-34

Option Description

- [1] ON: 6 Beeps. Standard Door Chime Enabled.OFF: Disabled. Standard Door Chime Disabled.
- [2] ON: Bing Bing Sound. OFF: Disabled
- [3] ON: Ding Dong Sound. OFF: Disabled
- [3] ON: Alarm Tone. The keypad will sound a medium volume alarm signal for 4 seconds. OFF: Disabled
- [5-8] Future Use



Enable one Door Chime option for each zone. If more than one option is enabled, the last numerical option enabled will take precedence. For example, if options 3 and 1 are both enabled, then the zone will sound 'Ding-Dong'. If all Door Chime options are disabled, the keypad will not sound a Door Chime tone for that particular zone.

Section [996] Label Reset

Resets Programmable Labels to Factory Defaults. Entering this section and pressing [*] returns all programmable system labels to the default conditions. This does not affect any of the keypad configuration sections.

Section 9: Testing & Troubleshooting

Testing:

- Power up system
- Program options as required (See **Programming Section**)
- Violate, then restore zones
- Verify correct **Reporting Codes** are sent to the Central Station

Troubleshooting:

- Power up system
- Enter *[2] to view **Troubles**
- Perform actions indicated in the tables below.

Trouble Summary:

Trouble [1]* Service Required - Press [1] for more information

Low Battery

General System Trouble

General System Tamper

Trouble [2] AC Trouble

Trouble [3] Telephone Line Trouble

Trouble [4] Failure to Communicate

Trouble [5]* Zone Fault -Press [5] for more information

Trouble [6]* Zone Tamper - Press [6] for more information

Trouble [7]* Wireless Device Low Battery - Press [7] for more information

Trouble [8] Loss of Time or Date

Trouble	Cause	Troubleshooting
---------	-------	-----------------

Trouble [1] Service Required

Press [1] to determine specific trouble

Low Battery	Main panel battery less than 7.2VDC NOTE: This trouble condition will not clear until the battery voltage is 7.6VDC min., under load.	NOTE: If battery is new allow 24 Hrs. for battery to charge. <ul style="list-style-type: none"> • Verify voltage measured across AC terminals is 16-18 VAC. Replace transformer if required. • Disconnect then reconnect battery leads.
General System Trouble	The system has detected the presence of a RF Jam for 20s or communications with the wireless receiver have failed causing a Hardware Fault.	Check Event buffer to determine specific trouble. If Buffer logs RF Jam trouble: <ul style="list-style-type: none"> • Check for external 433MHZ signal sources To disable RF Jam: enable Option [7] in program section [804] subsection [90]. <ul style="list-style-type: none"> • If Buffer logs Hardware fault - Replace Panel
General System Tamper	Cover tamper tripped	<ul style="list-style-type: none"> • Verify that tamper button is installed into back plate • Verify that keypad (cover) is secured to backplate.

Trouble [2] AC Failure

	No AC at panel AC input terminals	<ul style="list-style-type: none"> • Verify voltage measured across AC terminals is 16-18VAC. Replace transformer if required.
--	-----------------------------------	---

Trouble [3] Telephone Line Trouble

	Phone Line Voltage at TIP, RING on main panel less than 3VDC	<ul style="list-style-type: none"> • Measure the voltage across TIP and RING on the panel: <ul style="list-style-type: none"> • No phone off-hook – 50VDC (approx.) • Any phone off-hook – 5VDC (approx.) • Wire incoming line directly to TIP and RING. <ul style="list-style-type: none"> • If trouble clears, check wiring or the RJ-31x phone jack.
--	--	--

Trouble [4] Failure to Communicate

	<p>Panel fails to communicate one or more events to central station</p>	<p>Connect a headset to TIP and RING of the control panel. Monitor for the following conditions:</p> <ul style="list-style-type: none"> • Continuous dial tone <ul style="list-style-type: none"> • Reverse TIP and RING • Recorded operator message comes on <ul style="list-style-type: none"> • Verify correct phone number is programmed • Dial the number programmed using a regular telephone to determine if a [9] must be dialed or if 800 service is blocked. • Panel does not respond to handshakes. <ul style="list-style-type: none"> • Verify the format programmed is supported by the central station. • Panel transmits data multiple times without receiving a handshake <ul style="list-style-type: none"> • Verify that the account number and reporting codes are correctly programmed. <p>NOTE: Contact ID and Pulse formats</p> <ul style="list-style-type: none"> • Program a HEX [A] to transmit a digit [0] <p>SIA format</p> <ul style="list-style-type: none"> • Program a digit [0] to transmit a digit [0]
--	---	--

Trouble [5] Zone Fault Press [5] to determine specific zones with a Fault trouble

	<p>Hard-wired zone fault condition present. A short circuit is present on one or more zones with double end-of-line resistors enabled</p>	<ul style="list-style-type: none"> • Remove the wire leads from I/O and COM terminals and measure the resistance of the wire leads. <p>Connect a 5.6K resistor (Green, Blue, Red) across the I/O and COM terminals. Verify the trouble condition clears.</p>
	<p>One or more wireless devices have not checked in within the programmed time</p>	<ul style="list-style-type: none"> • Perform a Module Placement Test – Program Section [904] and verify the wireless device is in a good location. <ul style="list-style-type: none"> • If bad test results occur, test the wireless device in another location • If the wireless device now tests good, the original mounting location is bad • If the wireless device continues to give bad test results replace the wireless device.

Trouble [6] Zone Tamper Press [6] to determine specific zones with a Tamper trouble

	<p>An open circuit is present on one or more zones with double end-of-line resistors enabled</p>	<ul style="list-style-type: none"> • Remove the wire leads from I/O and COM terminals and measure the resistance of the wire leads. • Connect a 5.6K resistor (Green, Blue, Red) across the I/O and COM terminals. • Verify the trouble condition clears.
	<p>A tamper condition is present on one or more wireless devices</p>	<ul style="list-style-type: none"> • Ensure device cover is secure • Ensure device is correctly mounted for wall tamper operation • Violate, then restore the tamper: <ul style="list-style-type: none"> • If tamper condition persists then replace wireless device

Trouble [7] Wireless Device Low Battery Press [7] to scroll through specific devices with a Low Battery Trouble

<p>1st press – Wireless Zones 2nd press – Wireless Keys</p>	<p>One or more wireless devices has a low battery</p> <p>NOTE: The event will not be logged to the event buffer until the wireless device low battery delay time expires Program Section [377] Opt 9</p>	<p>Replace Battery</p> <ul style="list-style-type: none"> • Verify zone operation • Verify that tamper and low battery condition is cleared and reported <p>NOTE: Replacing batteries will cause a tamper. Replacing cover will restore the tamper causing the associated reporting codes to be sent to the Central Station.</p>
---	--	--

Trouble [8] Loss of Clock/Date

	<p>The main panel internal clock is not set</p>	<p>To program the time and date:</p> <ul style="list-style-type: none"> • Enter [*][6][Master Code] then Press [1] • Enter the time and date (in military) using the following format: HH:MM MM/DD/YY <p>Example. For 6:00 pm, Nov. 30, 2007 Enter: [18] [00] [11] [30] [07]</p>
--	---	---

Appendix A: Reporting Code Formats

The following tables contain Contact ID and Automatic SIA format reporting codes. See *Programming Sections [320]-[348] for Reporting Codes Contact ID*

The first digit (in parentheses) will automatically be sent by the control. The second two digits are programmed to indicate specific information about the signal. For example, if zone 1 is an entry/exit point, you could program the event code as [34]. The central station would receive the following:

*BURG - ENTRY/EXIT - 1 where the "1" indicates which zone went into alarm.

SIA Format - Level 2 (Hard Coded)

The SIA communication format used in this product follows the level 2 specifications of the SIA Digital Communication Standard - October 1997. This format will send the Account Code along with its data transmission. The transmission will look similar to the following at the receiver:

```
N Ri1    BA 01
  N    =  New Event
  Ri1  =  Partition /Area Identifier
  BA   =  Burglary Alarm
  01   =  Zone 1
```

NOTE: A system event will use the Area Identifier Ri00.

Section #	Reporting Code	Code Sent When...	Dialer Direction*	Automatic Contact ID Codes	SIA Auto Rep Codes**
[320]-[323]	Zone Alarms	Zone goes into alarm	A/R	See the following tables on next page for details	
[324]-[327]	Zone Restorals	Alarm condition has been restored	A/R		
[328]	Duress Alarm	Duress code entered at keypad	A/R	(1) 21	HA-00
[328]	Opening After Alarm	System disarmed with alarm in memory	A/R	(4) 58	OR-UU
[328]	Recent Closing	Alarm occurs within two minutes of system arming	A/R	(4) 59	CR-00
[328]	Cross Zone (Police Code) Alarm	Two zones on the same partition go into alarm during any given armed-to-armed period (incl. 24Hr zones)	A/R	(1) 39	BM-00/BV-00
[328]	Burglary Not Verified		A/R	(3) 78	BG-00
[328]	Alarm Cancelled		A/R	(4) A6	BC-00
[329]	[F] Key Alarm/Rest.	Keypad fire alarm (alarm and restoral rep. codes sent together)	A/R	(1) 1A	FA-00/FH-00
[329]	[A] Key Alarm/Rest.	Keypad auxiliary alarm (alarm and restoral rep. codes sent together)	A/R	(1) AA	MA-00/MH-00
[329]	[P] Key Alarm/Rest.	Keypad panic alarm (alarm and restoral rep. codes sent together)	A/R	(1) 2A	PA-00/PH-00
[330]-[337]	Zone Tamper/Restoral	Zone is tampered / tamper condition restored	T/R	(3) 83	TA-ZZ/TR-ZZ
[338]	General System Tamper/Rest.	Case/cover has a tamper alarm. Case/cover tamper restored	T/R	(1) 45	ES-00/EJ-00
[338]	Keypad Lockout	Maximum number of incorrect access codes has been entered at a keypad	T/R	(4) 61	JA-00
[339-341]	Closings	System armed (user 01-16, 40 indicated)	O/C	(4) A1	CL-UU
[341]	Partial Closing	One or more zones bypassed when system armed	O/C	(4) 56	CG-00
[341]	Special Closing	Closing (arming) using one of the following methods: quick arm, keyswitch, function key, maintenance code, DLS software, wireless key	O/C	(4) AA	CL-00
[341]	Exit Fault		O/C	(3) 74	EE-00
[342-344]	Openings	System disarmed (user 01-16, 40 indicated)	O/C	(4) A1	OP-UU
[344]	Special Opening	Opening (disarming) using one of the following methods: key-switch, maintenance code, DLS software, wireless key	O/C	(4) AA	OP-00
[345]-[346]	Battery Trouble/Rest.	SCW System battery is low/battery restored	MA/R	(3) A2	YT-00/YR-00
[345]-[346]	AC Line Trouble/Rest.	AC power to control panel is disconnected or interrupted/AC power restored (Both codes follow AC Failure Comm. Delay.)	MA/R	(3) A1	AT-00/AR-00
[345]-[346]	Fire Trouble/Rest.	Trouble occurs/Restoral on a fire zone	MA/R	(3) 73	FT-00/FH-00
[345]-[346]	Auxiliary Power Trouble/Rest.	Aux voltage supply trouble/restoral	MA/R	(3) 12	YP-00/YQ-00
[346]	TLM Restoral	Telephone line restored	MA/R	(3) 51	LR-01
[345]-[346]	Gen. System Trouble/Rest.	"Service Required" trouble occurs (view troubles using [*][2])/trouble restored	MA/R	(3) AA	YX-00/YZ-00
[347]	Phone# 1 or 2 FTC Restoral	Control panel has restored communications to central station on Phone# 1 or 2 (after FTC)	MA/R	(3) 54	YK-00
[347]	DLS Lead In	Downloading session start	MA/R	(4) 11	RB-00
[347]	DLS Lead Out	Downloading session complete	MA/R	(4) 12	RS-00
[347]	Zone Fault/Rest.	One or more zones have faults/restored	MA/R	(3) 80	UT-ZZ/UJ-ZZ
[347]	Delinquency	Programmed amount of time (days or hours) for delinquency has expired without zone activity, or without system being armed	MA/R	(6) 54***	CD-00
[347]	Wireless Device Low Battery Trouble/Rest.	Wireless zones, panic pendants, wireless keys have low battery/ all low batteries restored	MA/R	(3) 84	XT-00/XR-00 XT-ZZ/XR-ZZ****

Section #	Reporting Code	Code Sent When...	Dialer Direction*	Automatic Contact ID Codes	SIA Auto Rep Codes**
[347]	Installer Lead In	Installer's mode has been entered	MA/R	(6)27	LB-00
[347]	Installer Lead Out	Installer's mode has been exited	MA/R	(6)28	LS-00
[348]	Walk Test End	End of test	T	(6) A7	TE-00
[348]	Walk Test Begin	Beginning of test	T	(6) A7	TS-00
[348]	Periodic Test	Periodic system test transmission	T	(6) A2	RP-00
[348]	System Test	[*][6] bell/communications test	T	(6) A1	RX-00
[601]-[604]	Closings	System armed (user 33-95 indicated)	O/C	(4) A1	CL-UU
[605]-[608]	Openings	System disarmed (user 33-95 indicated)	O/C	(4) A1	OP-UU
* A/R = alarms/restorals; T/R = tampers/restorals; O/C = openings/closings; MA/R = miscellaneous alarms/restorals; T = test transmissions ** UU = user number (user01-16,40); ZZ = zone number (01-34) *** Use the "Fail to close" event code [(4)54] to report closing or activity delinquency. Ensure the central station is aware that this code is used. **** Zones are panic pendants are identified, wireless keys can be identified for openings and closings.					

Contact ID Zone Alarm/Restoral Event Codes

(as per SIA DCS: 'Contact ID' 01-1999):
 Program any of these codes for zone alarms/restorals when using the standard (non-automatic) Contact ID reporting format.

Medical Alarms	(1)34 Entry / Exit
(1)AA Medical	(1)35 Day / Night
(1)A1 Pendant Transmitter	(1)36 Outdoor
(1)A2 Fail to Report In	(1)37 Tamper
Fire Alarms	(1)38 Near Alarm
(1)1A Fire Alarm	General Alarms
(1)11 Smoke	(1)4A General Alarm
(1)12 Combustion	(1)43 Exp. module failure
(1)13 Water Flow	(1)44 Sensor tamper
(1)14 Heat	(1)45 Module Tamper
(1)15 Pull Station	(1)4A Cross Zone Police Code
(1)16 Duct	24 Hour Non-Burglary
(1)17 Flame	(1)5A 24 Hour non-Burg
(1)18 Near Alarm	(1)51 Gas detected
Panic Alarms	(1)52 Refrigeration
(1)2A Panic	(1)53 Loss of Heat
(1)21 Duress	(1)54 Water Leakage
(1)22 Silent	(1)55 Foil Break
(1)23 Audible	(1)56 Day Trouble
Burglar Alarms	(1)57 Low bottled Gas level
(1)3A Burglary	(1)58 High Temp
(1)31 Perimeter	(1)59 Low Temp
(1)32 Interior	(1)61 Loss of Air Flow
(1)33 24 Hour	

SIA Format Automatic Zone Alarm/Restoral Codes

Zone Definition	SIA Auto Rep Codes*	Contact ID Auto Rep Codes*
Delay 1	BA-ZZ/BH-ZZ	(1) 3A
Delay 2	BA-ZZ/BH-ZZ	(1) 3A
Instant	BA-ZZ/BH-ZZ	(1) 3A
Interior	BA-ZZ/BH-ZZ	(1) 3A
Interior Stay/Away	BA-ZZ/BH-ZZ	(1) 3A
Delay Stay/Away	BA-ZZ/BH-ZZ	(1) 3A
24-Hr. Supervisory	US-ZZ/UR-ZZ	(1) 5A
24-Hr. Supervisory Buzzer	UA-ZZ/UH-ZZ	(1) 5A
24-Hr. Burg	BA-ZZ/BH-ZZ	(1) 3A
24-Hr. Gas	GA-ZZ/GH-ZZ	(1) 51
24-Hr. Heat	KA-ZZ/KH-ZZ	(1) 58
24-Hr. Medical	MA-ZZ/MH-ZZ	(1) AA
24-Hr. Panic	PA-ZZ/PH-ZZ	(1) 2A
24-Hr. Emergency (non-medical)	QA-ZZ/QH-ZZ	(1) A1
24-Hr. Water	WA-ZZ/WH-ZZ	(1) 54
24-Hr. Freeze	ZA-ZZ/ZH-ZZ	(1) 59
Interior Delay	BA-ZZ/BH-ZZ	(1) 3A
Instant Stay/Away	BA-ZZ/BH-ZZ	(1) 3A
24-Hr. Non-latching Tamper	UA-ZZ/UH-ZZ	(1) 4A
Night Zone	BA-ZZ/BH-ZZ	(1) 3A
Delayed 24-Hr. Fire (Wireless)	FA-ZZ/FH-ZZ	(1) 1A
Standard 24-Hr. Fire (Wireless)	FA-ZZ/FH-ZZ	(1) 1A
24-Hr. Auto Verified Fire (Wireless)	FA-ZZ/FH-ZZ	(1) 1A

* ZZ = zones 01-34

Appendix B: Communicator Format Options

The following format options are programmable in section [350] on page 23

- | | |
|----|---------------------------|
| 01 | 20 BPS, 1400 Hz handshake |
| 02 | 20 BPS, 2300 Hz handshake |

- **BPS Formats - 0 is not valid in Account or Rep Code (A must be used)**

Depending on the pulse format selected the panel will communicate using the following:

- 3/1, 3/2, 4/1 or 4/2
- 1400 or 2300 Hz handshake
- 20 bits per second
- non-extended

The digit '0' will send no pulses and is used as a filler. When programming account numbers enter four digits. When programming a three digit account number the fourth digit must be programmed as a plain '0' which will act as a filler digit.

If an account number has a '0' in it, substitute a HEX digit 'A' for the '0'. Examples:

- 3 digit account number [123]- program [1230]
- 3 digit account number [502] - program [5A20]
- 4 digit account number [4079] - program [4A79]

When programming reporting codes two digits must be entered. If one digit reporting codes are to be used the second digit must be programmed as a '0'. If a '0' is to be transmitted substitute a HEX digit 'A' for the '0'.

Examples:

- 1 digit reporting code [3] - program [30]
- 2 digit reporting code [30] - program [3A]

To prevent the panel from reporting an event program the reporting code for the event as [00] or [FF].

03	DTMF Contact ID
----	------------------------

- **ADEMCO Contact ID - 0 is not valid in Account or Rep Code (A must be used, 10 in checksum)**

Contact ID is a specialized format that will communicate information quickly using tones rather than pulses. In addition to sending information more quickly the format also allows more information to be sent. For example, rather than reporting an alarm zone 1 the Contact ID format can also report the type of alarm, such as Entry/Exit alarm zone 1.

If **Contact ID Sends Automatic Reporting Codes** is selected, the panel will automatically generate a reporting code for each event. These identifiers are listed in Appendix A. If the Automatic Contact ID option is not selected, reporting codes must be programmed. The 2-digit entry determines the type of alarm. The panel will automatically generate all other information, including the zone number.

NOTE: If the Automatic Contact ID option is selected, the panel will automatically generate all zone and access code numbers, eliminating the need to program these items.

NOTE: The zone number for Zone Low Battery and Zone Fault events will not be identified when Programmed Contact ID is used.

If the **Contact ID uses Automatic Reporting Codes** option is enabled, the panel will operate as follows:

- If an event's reporting code is programmed as [00], the panel will not attempt to call the central station.
- If the reporting code for an event is programmed as anything from [01] to [FF], the panel will automatically generate the zone or access code number. See Appendix A for a list of the codes which will be transmitted.

If the **Contact ID uses Programmed Reporting Codes** option is enabled, the panel will operate as follows:

- If an event's reporting code is programmed as [00] or [FF], the panel will not attempt to call central station.
- If the reporting code for an event is programmed as anything from [01] to [FE], the panel will send the programmed reporting code.

Account numbers must be four digits.

- If the digit '0' is in the account number substitute the HEX digit 'A' for the '0'.
- All reporting codes must be two digits.
- If the digit '0' is in the reporting code substitute the HEX digit 'A' for the '0'.
- To prevent the panel from reporting an event program the reporting code for the event as [00] or [FF].

See: Contact ID Sends Automatic Reporting Codes Section [381], Option [7]

04 SIA FSK

- **SIA -0 is valid in Account or Rep Code (not 00 in a Reporting code though)**
- **This format uses 300 Baud FSK as the communication media. The Account Code can be 4 or 6 hexadecimal digits in length, All reporting codes must be 2 digits in length. The SIA format will transmit a 4 (or 6) digit account code, a 2 digit identifier code and a 2 digit reporting code. The 2 digit identifier is pre programmed by the panel.**

SIA is a specialized format that will communicate information quickly using frequency shift keying (FSK) rather than pulses. The SIA format will automatically generate the type of signal being transmitted, such as Burglary, Fire, Panic etc. The two digit reporting code is used to identify the zone or access code number.

If the SIA format is selected the panel can be programmed to automatically generate all zone and access code numbers eliminating the need to program these items.

If the **SIA Sends Automatic Reporting Codes** option is enabled the panel will operate as follows:

1. If the reporting code for an event is programmed as [00] the panel will not attempt to call the central station.
2. If the reporting code for an event is programmed as anything from [01] to [FF] the panel will AUTOMATICALLY generate the zone or access code number.
3. Bypassed zones will always be identified when partial closing the system.

The Communicator Call Direction Options can be used to disable reporting of events such as Openings/Closings. Also, if all the Opening/Closing reporting codes were programmed as [00] the panel would not report.

If the **SIA Sends Automatic Reporting Codes** option is disabled the panel will operate as follows:

1. If the reporting code for an event is programmed as [00] or [FF] the panel will not attempt to call the central station.
2. If the reporting code for an event is programmed as anything from [01] to [FE] the panel will send the programmed reporting code.
3. Bypassed zones will not be identified when partial closing the system.

NOTE: The zone number for Zone Low Battery and Zone Fault events will not be identified when Programmed SIA is used.

**See: SIA Sends Automatic Reporting Codes - Section [381], Option [3],
Communicator Call Direction Options - Section [351] to [376],
SIA Identifiers - Appendix A**

05 Pager

The **Communicator Format** option for either telephone number can be programmed for Pager Format. If an event occurs and the **Communicator Call Direction** options direct the call to a telephone number with the Pager Format selected the panel will attempt to page.

When calling a pager extra digits will be required to make it work properly. The following is a list of Hex digits and what function they perform:

Hex [A] - not used

Hex [B] - simulates the [] key on a touch tone telephone

Hex [E] - two second pause

Hex [C] - simulates the [#] key on a touch tone telephone

Hex [F] - end of telephone number marker

Hex [D] - forces the panel to search for dial tone

The panel will attempt to call the pager one time. After dialing the digits in the telephone number the panel will send the account number and reporting code followed by the [#] key (Hex [C]).

There is no ring-back when using Pager Format. The panel has no way of confirming if the pager was called successfully; a failure to communicate trouble will only be generated once the maximum number of attempts has been reached.

NOTE: Do not use the digit C in a reporting code when using Pager Format. In most cases, the digit C will be interpreted as a [#], which will terminate the page before it has finished.

NOTE: If the panel detects a busy signal, it will attempt to page again. It will make the maximum number of attempts programmed in section [165].

Force dialing should be disabled when using Pager format.

NOTE: When using Pager format, you must program two hex digit E's at the end of the telephone number.

06 Residential Dial

If Residential Dial is programmed and an event that is programmed to communicate occurs, the panel will seize the line and dial the appropriate telephone number(s). Once the dialing is complete, the panel will emit an ID tone and wait for a handshake (press a 1, 2, 3, 4, 5, 6, 7, 8, 9, 0, * or # key from any telephone). It will wait for this handshake for the duration of **Post Dial Wait for Handshake** timer. Once the panel receives the handshake, it will emit an alarm tone over the telephone line for 20 seconds. If several alarms occur at the same time, only one call will be made to each telephone number the panel is programmed to call.

Appendix C: Regulatory Approvals Information

North America

This product has been tested and found in compliance with the following standards:

- UL1023 Household Burglar-Alarm System Units
- UL985 Household Fire Warning System Units
- UL1635 Digital Alarm Communicator System Units
- ULC-S545-02 Residential Fire Warning System Control Units
- ORD-C1023-1974 Household Burglar-Alarm System Units

This product has also been tested and found in compliance with the ANSI/SIA CP-01-2000 Control Panel Standard – Features for False Alarm Reduction.

This product is UL/ULC listed under the following categories:

- UTOU/UTOUC Control Units and Accessories, Household System Type
- NBSX/NBSXC Household Burglar Alarm System Units
- AMTB Control Panels, SIA False Alarm Reduction

The product is labeled with the UL and ULC listing marks along with the SIA CP-01 compliance statement (Also Classified in accordance with SIA-CP-01 Standard) as proof of compliance with the above mentioned standards. For further information on this product's listings please also refer to the official listing guides published at the UL web site (www.ul.com) under Certifications Section.

UL/ULC Residential Fire and Burglary Installations:

For ULC Installations refer to the Standard for the Installation of Residential Fire Warning Systems, CAN/ULC-S540.

- All burglary-type zones shall be configured with SEOL or DEOL configuration (refer to section [133] and [134], bit 15 or 16 shall be ON)
- Use at least one WS4916 Smoke Detector for Fire Installations (refer to section [001], fire zone shall be programmed as type 89)
- The entry delay shall not exceed 60 seconds (refer to section [005])
- The exit delay shall not exceed 120 seconds (refer to section [005])
- The minimum Bell Time-out is 4 minutes (refer to section [005])

Note: For ULC Residential Fire Installations the minimum Bell Time-out is 5 minutes

- Temporal Three Fire Signal shall be enabled (refer to section [013], option 8 shall be ON)
- Arm/Disarm Bell Squawk shall be enabled when using wireless key WS4939 (refer to section [014], option 1 shall be ON)
- Auxiliary Power boost shall be enabled (refer to section [014], option 4 shall be ON)
- A code shall be required for bypassing (refer to section [015], option 5 shall be ON)
- Trouble beeps shall be enabled (refer to section [023], option 7 shall be ON)
- AC trouble indication LED shall be enabled (refer to Keypad Programming, section [075], options 5 and 6 shall be ON)
- DACT Communicator shall be enabled for Supervising Station Monitoring (refer to section [380], option 1 shall be ON).

Note: The DACT communicator for this product has no line security.

- Telephone Line Monitoring (TLM) shall be enabled (refer to section [015], option 7 shall be ON)

Note: This product is programmed to perform 5 attempts for communication of an event to the supervising station. If unsuccessful, a Fail To Communicate (FTC) trouble is generated.

- Test transmission cycle shall be set for monthly transmission (refer to section [377])

Note: For ULC Residential installations set for daily test transmission

- Wireless Supervision window shall be enabled (refer to Wireless Programming, sections [82] to [85])
- Wireless Supervision window shall be set to 4h for Fire Installations (refer to Wireless Programming, section [81] shall be programmed with the value [16])
- Wireless Supervision window shall be set to 24h for Burglary Installations only (refer to Wireless Programming, section [81] shall be programmed with the value [96])
- RF Jam detection shall be enabled (refer to Wireless Programming, section [90], option 7 shall be OFF)
- Bells will be active During 2-way Audio (refer to section [600], opt 7 shall be ON)
- New Alarms will Disconnect 2-way Audio (refer to section [023], opt 6 shall be OFF)
- When the 2- way audio feature is enabled (section [381] option 5 is ON) ensure that section [023] option 6 is OFF and section [600] option 7 is ON

Programming

The notes in the programming sections describing the system configurations for UL/ULC listed installations shall be implemented

Bell Location

The alarm sounding device (bell) shall be located where it can be heard by the person operating the security system during the daily arming and disarming cycle.

Casual Users

The installer should caution the user(s) not to give system information (e.g. codes, bypass methods, etc.) to casual users (baby-sitters or service people). Only the One-Time Use codes shall be given to casual users.

User Information

The installer should advise the users and note in the User's Manual:

- Service organization name and telephone number
- The programmed exit time
- The programmed entry time
- Test system weekly

SIA False Alarm Reduction Installations

For a list of the defaults value programmed when the unit is shipped from the factory and for any other programming information refer to Appendix D: False Alarm Reduction.

Caution

Call Waiting Cancel (Section [382], Option 4) feature on a non-Call Waiting line will prevent successful communication to the supervising station.

Fire Alarm Verification feature (Auto Verified Fire Zone type [89]) is supported on the DSC Wireless Smoke Detector, Model WS4916. The fire alarm delay is 40s.

Notes

Programming at installation may be subordinate to other UL requirements for the intended application

Cross zones have the ability to individually protect the intended area (e.g. motion detectors which overlap)

Cross zoning is not recommended for line security Installations nor is to be implemented on exit/entry zones.

There is a communication delay of 30 seconds in this control panel. It can be removed, or it can be increased up to 45 seconds at the option of the end user by consulting with the installer.

Do not duplicate any reporting codes. This applies for all communication formats other than SIA or CID sending automatic programmed reporting codes.

The security system shall be installed with the sounding device activated and the communicator enabled for transmission using SIA or CID format.

Europe



This product is in conformity with:

EMC Directive 89/336/EEC based on results using harmonized standards in accordance with article 10(5),

R&TTE Directive 1999/5/EC based on following Annex III of the directive and

LVD Directive 73/23/EEC as amended by 93/68/EEC based on results using harmonized standards.

The product is labeled with the CE mark as proof of compliance with the above mentioned European Directives. Also a CE declaration of conformity (DoC) for this product can be found at www.dsc.com under Agency Listings section.

DSC erklærer herved at denne komponenten overholder alle vigtige krav samt andre bestemmelser gitt i direktiv 1999/5/EC.

Por este meio, a DSC, declara que este equipamento está em conformidade com os requisitos essenciais e outras determinações relevantes da Directiva 1999/5/EC.

"DSC bekräftar härmed att denna apparat uppfyller de väsentliga kraven och andra relevanta bestämmelser i Direktivet 1999/5/EC".

Con la presente la Digital Security Controls dichiara che questo prodotto è conforme ai requisiti essenziali ed altre disposizioni rilevanti relative alla Direttiva 1999/05/CE.

Por la presente, DSC declara que este equipo está en conformidad con los requisitos esenciales y otros requisitos relevantes de la Directiva 1999/5/EC.

Hierdurch erklärt DSC, daß dieses Gerät den erforderlichen Bedingungen und Voraussetzungen der Richtlinie 1999/5/EC entspricht.

'Αία του παρόντος, η DSC, δηλώνει ότι αυτή η συσκευή είναι σύμφωνη με τις ουσιώδεις απαιτήσεις και με όλες τις άλλες σχετικές αναφορές της Οδηγίας 1999/5/EC'.

Hierbij verklaart DSC dat dit toestel in overeenstemming is met de eisen en bepalingen van richtlijn 1999/5/EC.

Par la présente, DSC déclare que cet article est conforme aux exigences essentielles et autres relevantes stipulations de la directive 1999/5/EC.

DSC vakuuttaa laitteen täyttävän direktiivin 1999/5/EC olennaiset vaatimukset.

Hereby, DSC, declares that this device is in compliance with the essential requirements and other relevant provisions of Directive 1999/5/EC.

The complete R & TTE Declaration of Conformity can be found at www.dsc.com/intl/rttedirect.htm.

New Zealand



The following is a list of warnings applicable when this equipment is connected to the New Zealand Telecom Network.

General Warning



The grant of a Telepermit for any item of terminal equipment indicates only that Telecom has accepted that the item complies with minimum conditions for connection to its network. It indicates no endorsement of the product by Telecom, nor does it provide any sort of warranty. Above all, it provides no assurance that any item will work correctly in all respects with another item of Telepermitted equipment of a different make or model, nor does it imply that any product is compatible with all of Telecom's network services.



Reverse Numbering (decadic signalling)

Decadic signalling should not be used as it is being progressively phased out of the network. DTMF dialling is 100% available and it should always be used.

Line Grabbing Equipment

This equipment is set up to carry out test calls at pre-determined times. Such test calls will interrupt any other calls that may be set up on the line at the same time. The timing set for such test calls should be discussed with the installer.

The timing set for test calls from this equipment may be subject to 'drift'. If this proves to be inconvenient and your calls are interrupted, then the problem of timing should be discussed with the equipment installer. The matter should NOT be reported as a fault to Telecom Faults Service.

D.C. Line Feed to Other Devices

During dialling, this device unit does not provide DC voltage to the series port connection and this may cause loss of memory functions for the terminal devices (local telephone) connected to T-1, R-1.

General Operation (ringer sensitivity and loading)

This device only responds to Distinctive Alert cadences DA1 and DA2.

Appendix D: SIA False Alarm Reduction

SIA Feature Programming Section	Comments	Range/Default	Requirement
Exit Time [005], 3rd entry	Access to Entry and Exit delays and Bell Time Out for the system	Range: 45- 255 seconds Default: 60 sec.	Required (programmable)
Progress Annunciation/ Disable - for Silent Exit [014], Option 6 ON	Enables audible exit beeps from the keypad for the duration of exit delay	Keypads may be disabled Default: Enabled	Allowed
Exit Time Restart [014], Option 2 ON	Enables the exit delay restart feature	Default: Enabled	Required
Auto Stay Arm on Unvacated Premises [001]-[002] Zone type 05, 06	Function Key: Stay Arming. All Stay/Away type zones (05, 06) will be automatically bypassed	If no exit after full arm Default: Enabled	Required
Exit Time and Progress Annunciation/Disable or Remote Arming [005] and [014] bit 6	System Times and Audible Exit beeps can be disabled when using the Key fob to arm away the system	Default: Enabled	Allowed
Entry delay(s) [005], 1st and 2nd entry	Access to Entry and Exit delays and Bell Time Out for the system Note: Combined Entry delay and Communications Delay (Abort Window) shall not exceed 60s	Range: 30 sec. to 4 min. Default: 30 sees	Required (programmable)
Abort Window for Non-Fire zones [101]-[134] bit 6 ON	Access to zone attributes, i.e, swinger shutdown, transmission delay and cross zone. Individual zones attribute bit 6 (Transmission delay) is by default ON	May be disabled by zone or zone type Default: Enabled	Required
Abort Window - for Non-Fire zones [377], 4th entry	Access to the programmable delay before communicating alarms Note: Combined Entry delay and Communications Delay (Abort Window) shall not exceed 60s	Range: 15 - 45 sec. Default: 30 sees	Required (programmable)
Abort Annunciation [382], Option 3 ON	Enables the "Communication Cancelled" message display on keypad	Annunciate that no alarm was transmitted Default: Enabled	Required
Cancel Annunciation [328], 8th entry	Access to the reporting code for Alarm Cancelled	Annunciate that a Cancel was transmitted Default: Enabled	Required
Duress Feature [*][5] Master Code Option 2 ON	Do not derive code from an existing Master/User code (e.g., Master code is 1234, the duress code should not be 1233 or 1235)	No 1+/- derivative of another user code. No duplicates with other user codes Default: disabled	Allowed
Cross Zoning [016] Option 1 [101]-[134] bit 8 OFF	This option enables Cross Zoning for entire system. Individual zones can be enabled for Cross zoning via Zone attribute bit 8 in sections [101] - [134]	Programming required Default: Disabled	Required
Cross Zone Timer [176]	Access to the programmable Cross Zone timer	May program Range: 001-255 sec./min. Default: 60 secs	Allowed
Swinger Shutdown for Alarms [377] 1st entry	Access to the swinger shutdown limit for zone alarms	For all non-fire zones shut down at 1 or 2 trips Default: 1 Trip	Required (programmable)
Swinger Shutdown Enable [101] - [134] bit 6 ON	Access to zone attributes, i.e., swinger shutdown, transmission delay and cross zone. Individual zones attribute bit 6 (Swinger shutdown enabled) is by default ON	For non-police response zones Default: Enabled	Allowed
24-Hr. Auto_verified Fire (Wireless) Zone type [89]	Access to 24-Hr. Auto_verified Fire (Wireless)	Activates If a restoral is Not received within the specified time Default: disabled	Required
Call Waiting Cancel Dial String [304], [382], Option 4 OFF	Access to the dialing sequence used to disable call waiting	Dependant on user phone line Default: disabled	Required

Testing

System Test: [*][6] Master Code, Option 4	The system activates all keypad sounders, bells or sirens for 2 seconds and all keypad lights turn on. Refer to the <i>User Manual (part no. 29007326)</i> .
Walk Test Mode: [*][6] Opt 8	This mode is used to test each zone on the system for proper functionality.
Alarm Communications During Walk Test [382] Option 2:	Enables Communication of zone alarms while Walk Test is active.
Walk Test End and Begin Reporting Codes [348], 1 st and 2 nd Entries	Access to the reporting codes for Walk Test Begin and Walk Test End.

Appendix E: 2-Way Audio Verification (SCW9047 only)

The following information is intended for use by the Central Station Operator.

The SCW9047 Audio Verification provides Talk and Listen-in capability for audio verification of alarms. This allows the central station to communicate with the occupants through the microphone and speaker of the alarm system. The commands indicated below are a subset of the SIA Audio Verification Standard (November 11, 1997)

The 2-way Audio Session

1. **Zone Violation:** A 2-way audio session begins with the violation of a zone that has zone attribute 9 enabled.

By default the following do NOT initiate a 2-way session:

- Fire Zones, zone 87, 88, 89 and the Fire Key
- Supervisory zones, zones 9 and 10
- 24 Hr Freeze zone, zone 20

By default 1-way audio (Listen-in only) is initiated by the following:

- Silent Panic events (Silent [P], Silent Panic zone)
- Duress alarm
- Silent zone alarm (Zone attribute 1 OFF)

NOTE: The Operator can **NOT** switch to Talk mode (Speaker is always **OFF**)

2. **Communication to the Monitoring Station:** When the appropriate Alarm is triggered one of the following reporting codes/actions is sent to the monitoring station.

Format	Reporting Code/Event
SIA	L90
Contact ID	606
BPS	Communicates the Event, then automatically enters into 2-way Audio mode

3. **Alerting the Operator:** When the reporting code is received by the monitoring station or a 2-way session is automatically initiated, a 2-way Initiation (Start) tone will be sounded to alert the operator. A high (1800 Hz) tone and a low (900 Hz) tone are used to generate the following Session Tones. Short tone duration is 100ms. Long tone duration is 1 second.:

2-way Initiation (Start) Tone:	
3 Hi Tones (Short)	After the third short Hi tone has sounded, the system switches directly into Listen-in mode without a keypress from the monitoring station.
Reminder Tones:	
1 Hi Tone (Short)	1 Short Hi Tone indicates 20 seconds are left in the audio session
1 low Tone	1 Short Low Tone indicates 10 seconds are left in the audio session
Subsequent Alarm:	
1 Hi Tone Long	1 long Hi Tone indicates a new alarm event if Section [023] Option 6 (New Alarms will not disconnect 2-way Audio) is enabled, alarms will be delayed. If disabled the audio session will terminate. NOTE: Receiving a subsequent alarm event tone will not restart the 90 second session timer.
Subsequent Fire Event:	
Hi, Low, Hi (Short)	3 short (100ms) tones Hi, Low, Hi indicates a new Fire alarm if Section [023] Option 6 (New Alarms will not disconnect 2-way Audio) is enabled. If disabled the audio session will terminate. NOTE: Receiving a subsequent Fire alarm event tone will not restart the 90 second session timer.

4. **Initiating, Control and Termination of the Session:** The Operator controls the session the using the following Audio Control Telephone Key Functions.To select the following commands, Press [*][0] followed by the key number(s) indicated below

Key	Command	Description
0	Future Use	
1/4	Talk to Speaker	Connects the monitoring station to the speaker .
2	VOX Mode	Connects the monitoring station to the system in VOX Mode (See VOX Support below)
3/6	Listen to Microphone	Connects the monitoring station to the microphone.
4	Lo-Gain Talk to Speaker	Connects the monitoring station to the speaker at the low volume output level.
5	Future Use	
6	Lo-Gain Listen to Microphone	Connects the monitoring station to the microphone at the low gain input level.
7	Extend Time	Restarts the session timer (90 seconds) to prevent timeout. To extend the time and take no other action use this function. Pressing any key automatically extends the time.
88	Future Use	
99	Disconnect	Disconnects the session. The second '9' must be pressed within 1 second of pressing the first '9'. Use the "Disconnect" key sequence before hanging up during a Talk / Listen-In session.

VOX Support

When in VOX mode the SCW9047 automatically switch between the phone line and internal mic/speakers being active depending on which one is loudest. Push to Talk overrides VOX – this is performed by switching into a talk mode at the monitoring station .

Hang-up Auto-detection

The SCW9047 automatically disconnects if the central station receiver disconnects before the operator picks up the line. The SCW9047 will consider five seconds of continuous dial tone, or busy tone to be a disconnect condition.

Bell/Buzzer Silent During 2-Way Audio

When the panel has an audible alarm, the bell can be programmed to remain active until the 2-Way Audio session starts and then the bell will be silent (Section [600], option 7 off) to allow the user to hear the operator. All buzzer activity, except keypresses, will be silent when 2-way audio is active. If the panel has not been disarmed at the termination of the 2-Way Audio session, the bell will restart for the timeout duration. Door chime is disabled during a 2-way Audio session. Any activity that normally sounds door chime will occur and the door chime will not sound.

FCC COMPLIANCE STATEMENT

CAUTION: Changes or modifications not expressly approved by Digital Security Controls could void your authority to use this equipment.

This equipment has been tested and found to comply with the limits for a Class B digital device, pursuant to Part 15 of the FCC Rules. These limits are designed to provide reasonable protection against harmful interference in a residential installation. This equipment generates, uses and can radiate radio frequency energy and, if not installed and used in accordance with the instructions, may cause harmful interference to radio communications. However, there is no guarantee that interference will not occur in a particular installation. If this equipment does cause harmful interference to radio or television reception, which can be determined by turning the equipment off and on, the user is encouraged to try to correct the interference by one or more of the following measures:

- Re-orient the receiving antenna.
- Increase the separation between the equipment and receiver.
- Connect the equipment into an outlet on a circuit different from that to which the receiver is connected.
- Consult the dealer or an experienced radio/television technician for help.

The user may find the following booklet prepared by the FCC useful: "How to Identify and Resolve Radio/Television Interference Problems". This booklet is available from the U.S. Government Printing Office, Washington D.C. 20402, Stock # 004-000-00345-4.

IMPORTANT INFORMATION

This equipment complies with Part 68 of the FCC Rules and, if the product was approved July 23, 2001 or later, the requirements adopted by the ACTA. On the side of this equipment is a label that contains, among other information, a product identifier. If requested, this number must be provided to the Telephone Company.

Product Identifier: US:F53AL01B9047

USOC Jack: RJ-31X

Telephone Connection Requirements

A plug and jack used to connect this equipment to the premises wiring and telephone network must comply with the applicable FCC Part 68 rules and requirements adopted by the ACTA. A compliant telephone cord and modular plug is provided with this product. It is designed to be connected to a compatible modular jack that is also compliant. See installation instructions for details.

Ringer Equivalence Number (REN)

The REN is used to determine the number of devices that may be connected to a telephone line. Excessive RENs on a telephone line may result in the devices not ringing in response to an incoming call. In most but not all areas, the sum of RENs should not exceed five (5.0). To be certain of the number of devices that may be connected to a line, as determined by the total RENs, contact the local Telephone Company. For products approved after July 23, 2001, the REN for this product is part of the product identifier that has the format US: AA AEQ##TXXXX. The digits represented by ## are the REN without a decimal point (e.g., 03 is a REN of 0.3). For earlier products, the REN is separately shown on the label.

REN = 0.1B

Incidence of Harm

If this equipment (SCW9045/SCW9047) causes harm to the telephone network, the telephone company will notify you in advance that temporary discontinuance of service may be required. But if advance notice is not practical, the Telephone Company will notify the customer as soon as possible. Also, you will be advised of your right to file a complaint with the FCC if you believe it is necessary.

Changes in Telephone Company Equipment or Facilities

The Telephone Company may make changes in its facilities, equipment, operations or procedures that could affect the operation of the equipment. If this happens the Telephone Company will provide advance notice in order for you to make necessary modifications to maintain uninterrupted service.

This publication covers the following model(s):

- SCW9045-433
- SCW9047-433
- SCW9045-868†
- SCW9047-868†

† These models are not UL/ULC Listed (intended for European market)

Equipment Maintenance Facility

If trouble is experienced with this equipment (SCW9045/SCW9047) for repair or warranty information, contact the facility indicated below. If the equipment is causing harm to the telephone network, the Telephone Company may request that you disconnect the equipment until the problem is solved. This equipment is of a type that is not intended to be repaired by the end user.

DSC c/o APL Logistics 757 Douglas Hill Rd., Lithia Springs, GA 30122

Additional Information

Connection to party line service is subject to state tariffs. Contact the state public utility commission, public service commission or corporation commission for information.

Alarm dialling equipment must be able to seize the telephone line and place a call in an emergency situation. It must be able to do this even if other equipment (telephone, answering system, computer modem, etc.) already has the telephone line in use. To do so, alarm dialling equipment must be connected to a properly installed RJ-31X jack that is electrically in series with and ahead of all other equipment attached to the same telephone line. Proper installation is depicted in the figure below. If you have any questions concerning these instructions, you should consult your telephone company or a qualified installer about installing the RJ-31X jack and alarm dialling equipment for you.

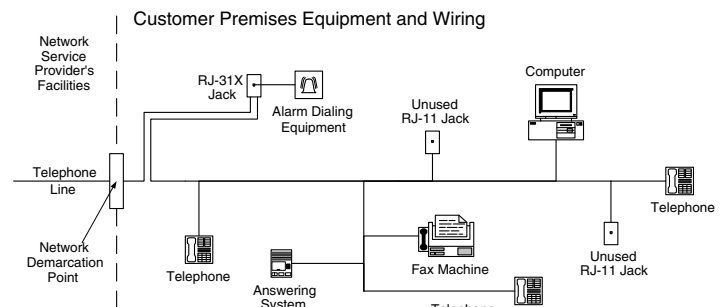

INDUSTRY CANADA STATEMENT

NOTICE: This product meets the applicable Industry Canada technical specifications.

Le présent matériel est conforme aux spécifications techniques applicables d'Industrie Canada.

The Ringer Equivalence Number (REN) for this terminal equipment is 0.1.

L'indice d'équivalence de la sonnerie (IES) du présent matériel est de 0.1.

The Ringer Equivalence Number is an indication of the maximum number of devices allowed to be connected to a telephone interface. The termination on an interface may consist of any combination of devices subject only to the requirement that the sum of the RENs of all the devices does not exceed five.

L'indice d'équivalence de la sonnerie

(IES) sert à indiquer le nombre maximal de terminaux qui peuvent être raccordés à une interface téléphonique. La terminaison d'une interface peut consister en une combinaison quelconque de dispositifs, à la seule condition que la somme d'indices d'équivalence de la sonnerie de tous les dispositifs n'excède pas 5.

The term "IC:" before the radio certification number only signifies that Industry Canada technical specifications were met.

Certification Number IC: 160A-9047

This Class B digital apparatus complies with Canadian ICES-003.

Cet appareil numérique de la classe B est conforme à la norme NMB-003 du Canada.

DSC

© 2007, Digital Security Controls
Tech Support: 1-800-387-3630 (Canada & U.S.) or 905-760-3036

Release Date Jan 13/2008 • Printed in Canada

WWW.DIYALARMFORUM.COM • www.dsc.com



29007324R002